

# storm vault™

## MODEL SV68X6

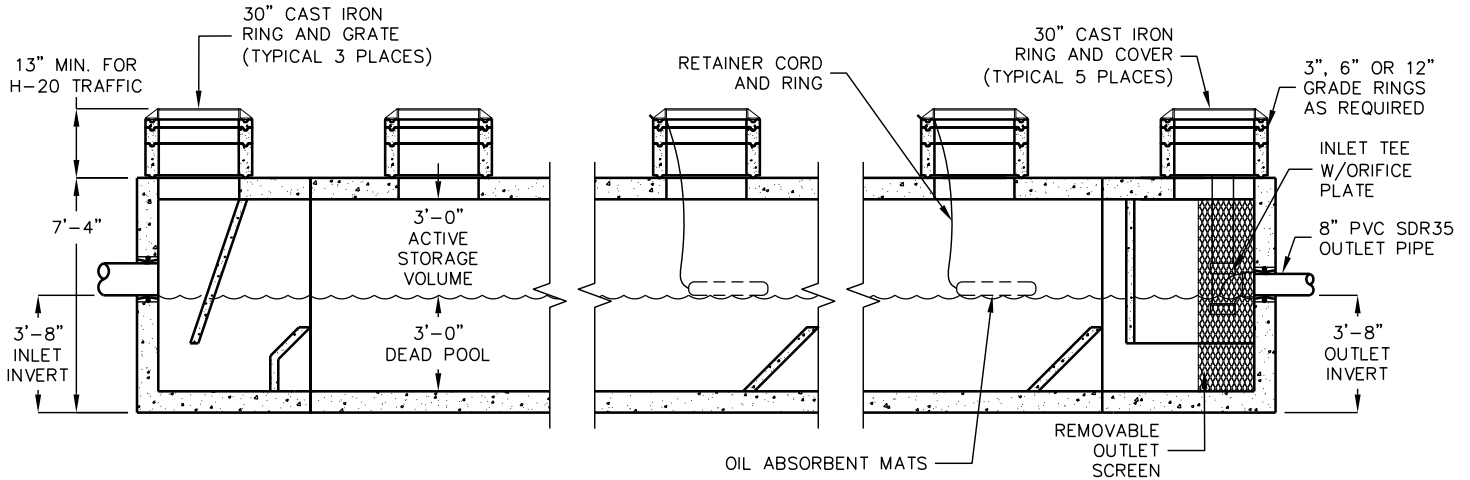

### SECTION VIEW

CUT AWAY

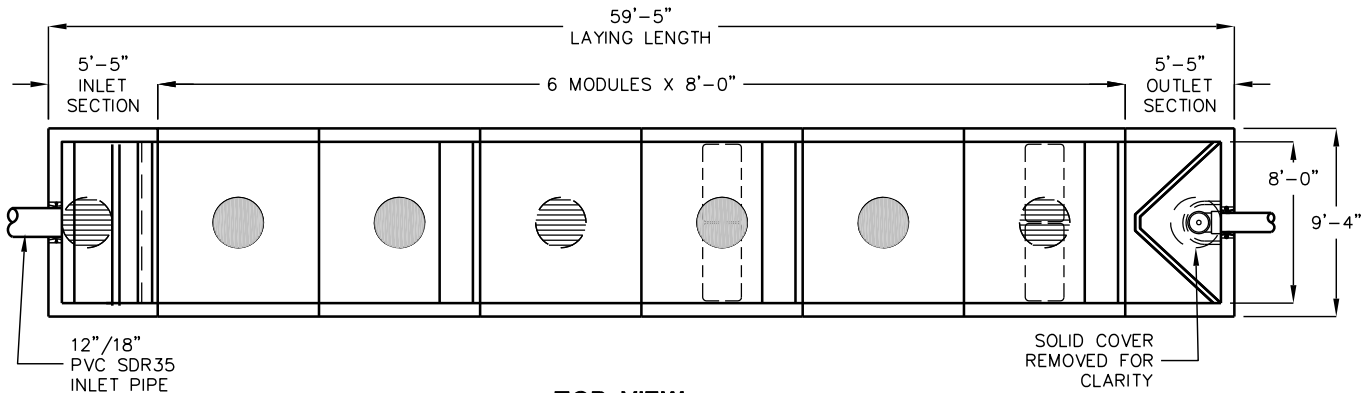

### TOP VIEW

COVERS AND RISERS REMOVED

U.S. PATENT NO.  
6,350,374  
OTHER U.S. AND FOREIGN  
PATENTS PENDING.

FOR COMPLETE DESIGN  
AND PRODUCT INFORMATION  
CONTACT JENSEN PRECAST.

DESIGN LOAD: H-20 TRAFFIC FROM 13"  
TO 6' SOIL COVER.

NOTE:  
ACCESS TO ALL VAULT SECTIONS WILL  
BE PROVIDED BY 30" MANHOLES  
UNLESS OTHERWISE SPECIFIED.