

storm vault™

MODEL SV88X15

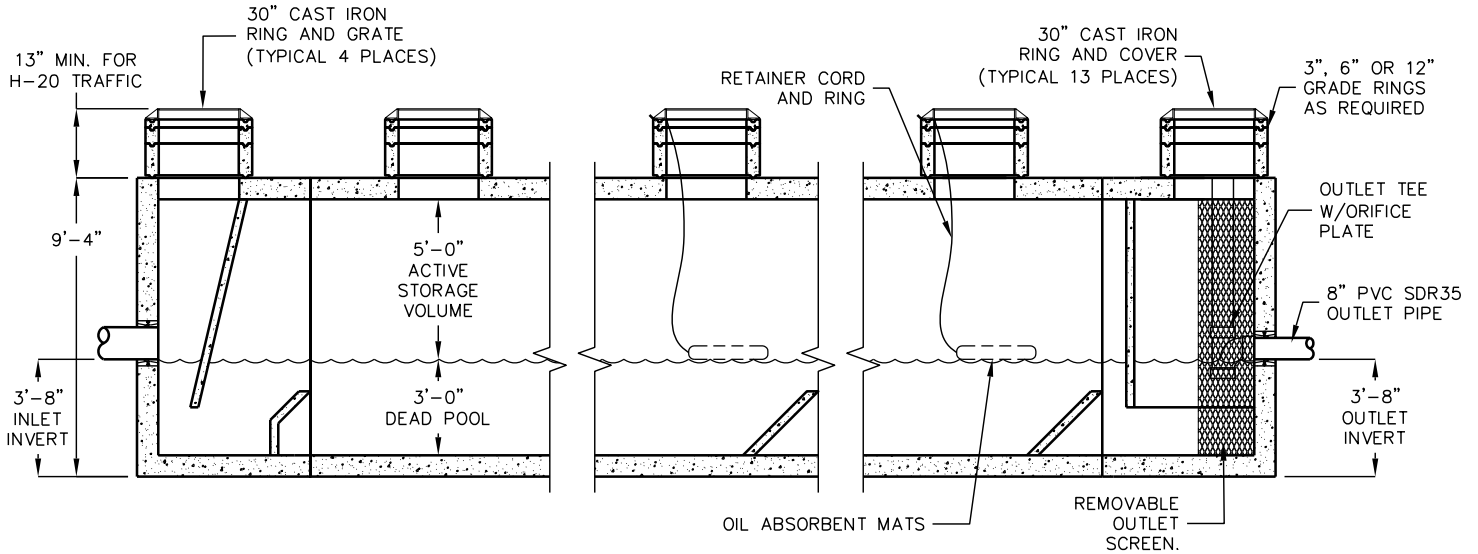

SECTION VIEW

CUT AWAY

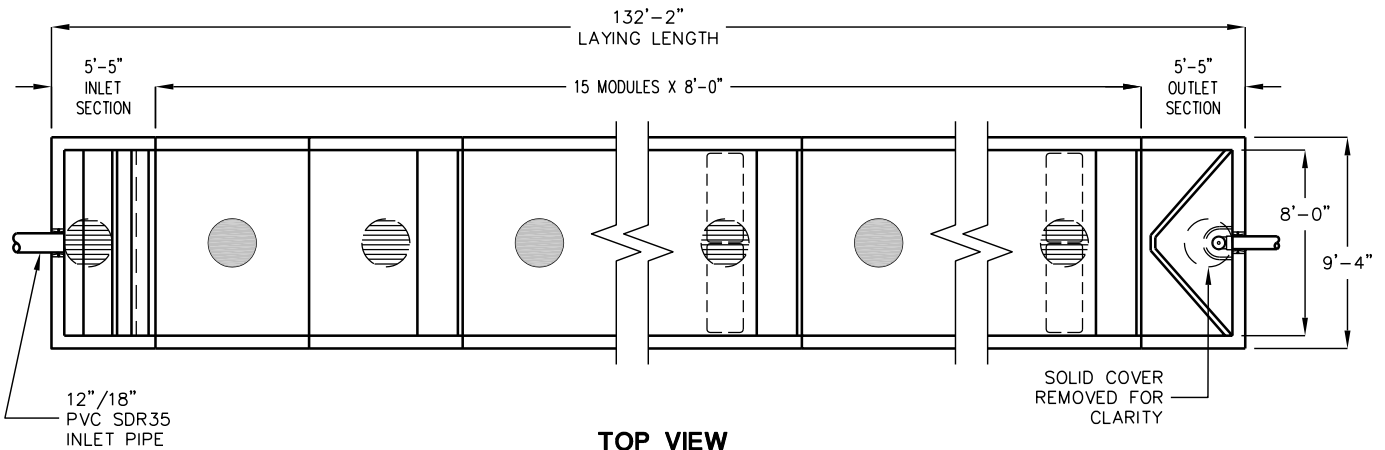

TOP VIEW

COVERS AND RISERS REMOVED

U.S. PATENT NO.
6,350,374
OTHER U.S. AND FOREIGN
PATENTS PENDING.

FOR COMPLETE DESIGN
AND PRODUCT INFORMATION
CONTACT JENSEN PRECAST.

DESIGN LOAD: H-20 TRAFFIC FROM 13"
TO 6' SOIL COVER.

NOTE:
ACCESS TO ALL VAULT SECTIONS WILL
BE PROVIDED BY 30" MANHOLES
UNLESS OTHERWISE SPECIFIED.