

# UM1-5C-2 PAD ASSEMBLY

90" X 96" X 8"

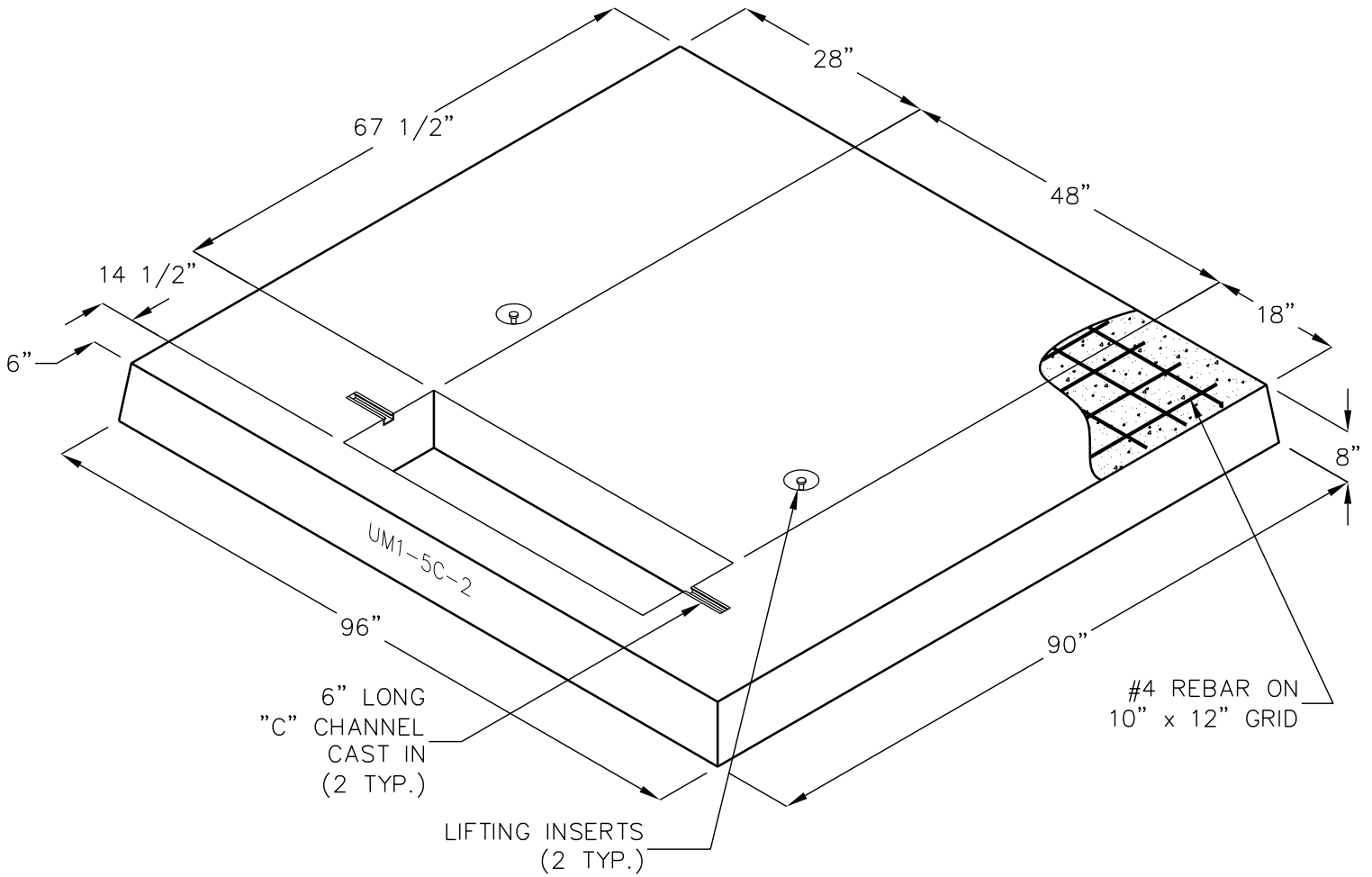

FOR COMPLETE DESIGN  
AND PRODUCT INFORMATION  
CONTACT JENSEN PRECAST.