

615-7 TELEPHONE MANHOLE

6' x 15' x 7' I.D.
MANHOLE

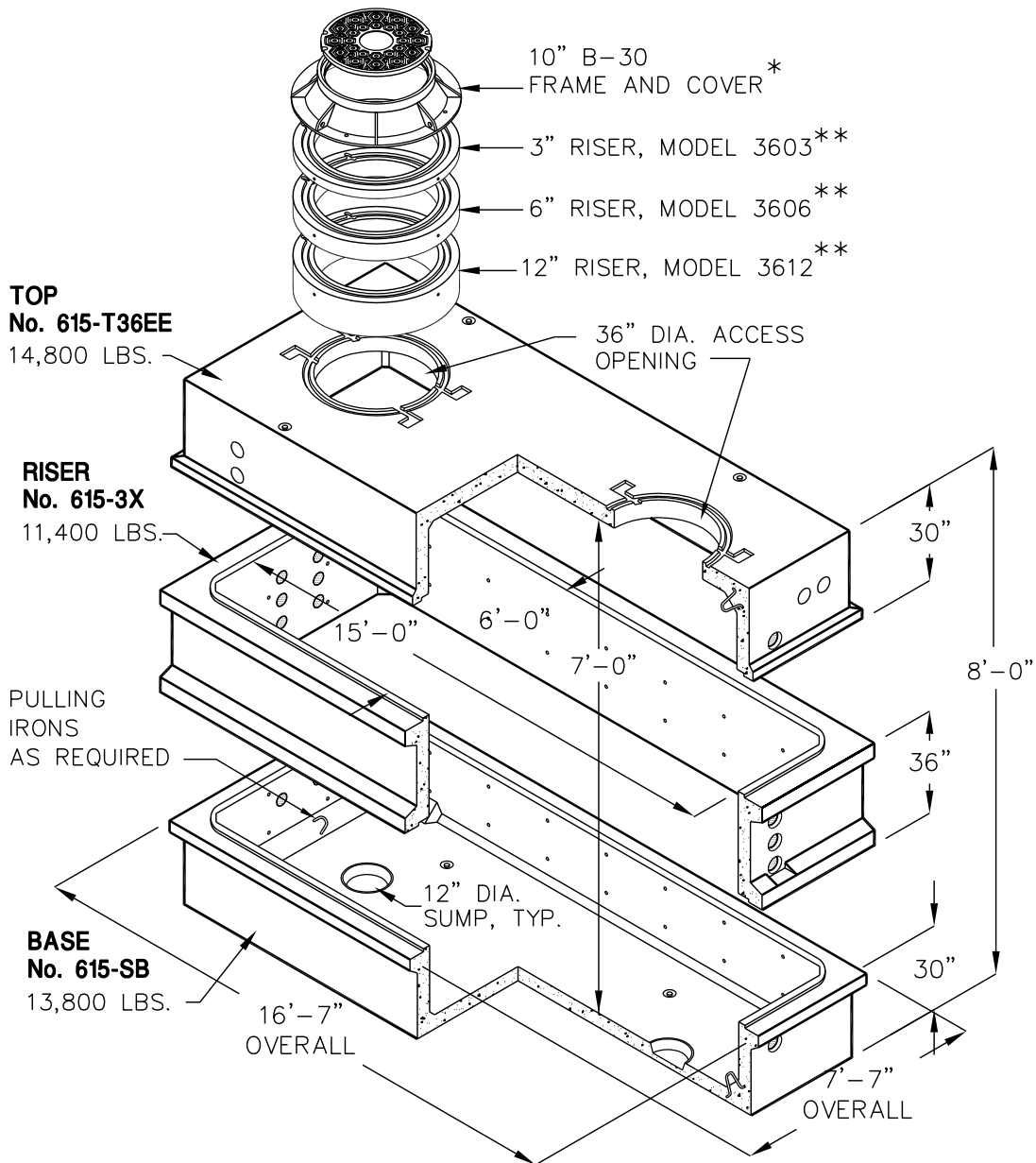

BOX DESIGN LOAD:
H-20 TRAFFIC
WITH 1' TO 5' EARTH COVER

FOR COMPLETE DESIGN
AND PRODUCT INFORMATION,
CONTACT JENSEN PRECAST.

- * SEE HARDWARE/APPURTENANCES SECTION FOR SPECIFICATIONS.
- ** RISERS OPTIONAL. SEE COLLAR/RISER SECTION FOR SPECIFICATIONS.