

5000 GALLON COMMERCIAL SEPTIC TANK

MODEL TY5000-EE-ST-6D4W
TRAFFIC RATED
IAPMO LISTED

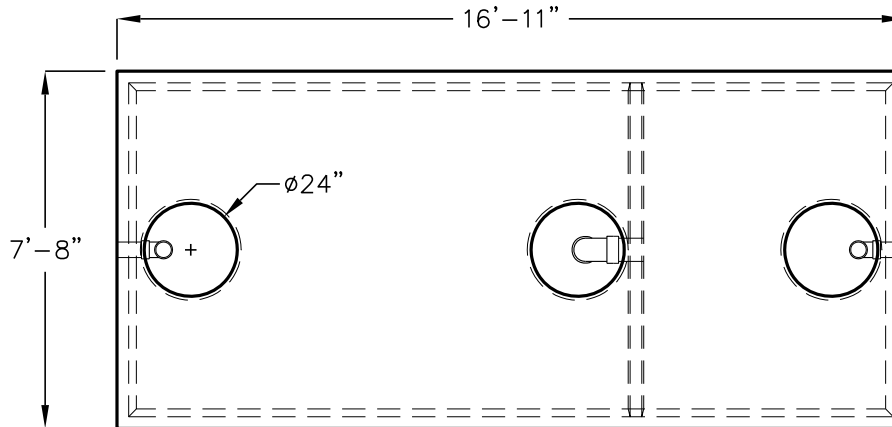

PLAN VIEW (COVERS NOT SHOWN)

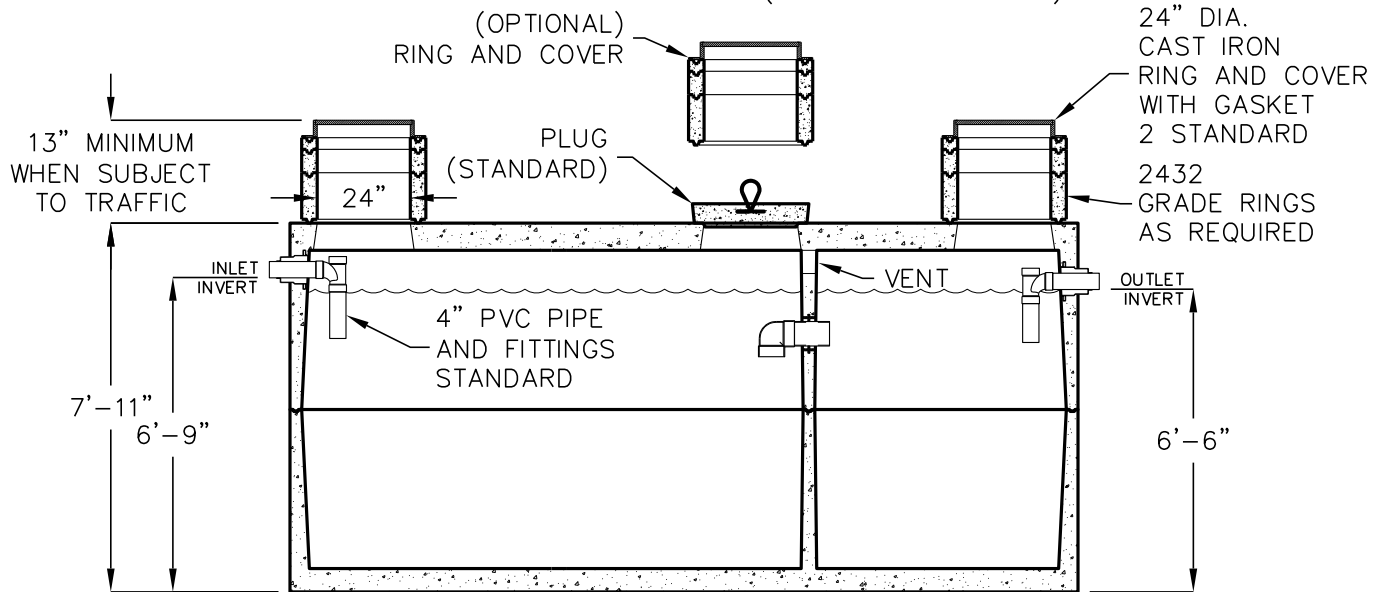

ELEVATION SECTION

OPERATING CAPACITY: 5000 GALLONS.

DESIGN LOAD: H-20 TRAFFIC WITH WATER TABLE 4 FEET BELOW FINISHED GRADE AND 13 INCHES TO 6 FEET EARTH COVER.

SUITABLE SUB-BASE BEDDED WITH GRANULAR MATERIAL SHALL BE PREPARED TO HANDLE ANTICIPATED LOADS.

FOR COMPLETE DESIGN AND PRODUCT INFORMATION CONTACT JENSEN PRECAST.

MINIMUM EXCAVATION
8'-8" x 17'-11"
x REQ'D DEPTH

Jensen Precast reserves the right to make changes to product design and/or dimensions without notice. Please contact Jensen Precast whenever necessary for confirmation or advice on product design.

JENSEN
PRECAST