

# PAD MOUNTED SWITCH PAD MODEL 15-U

MEETS NV ENERGY SPECS.  
DRAWING NO. PE0015 U  
STOCK NO. 24-0736

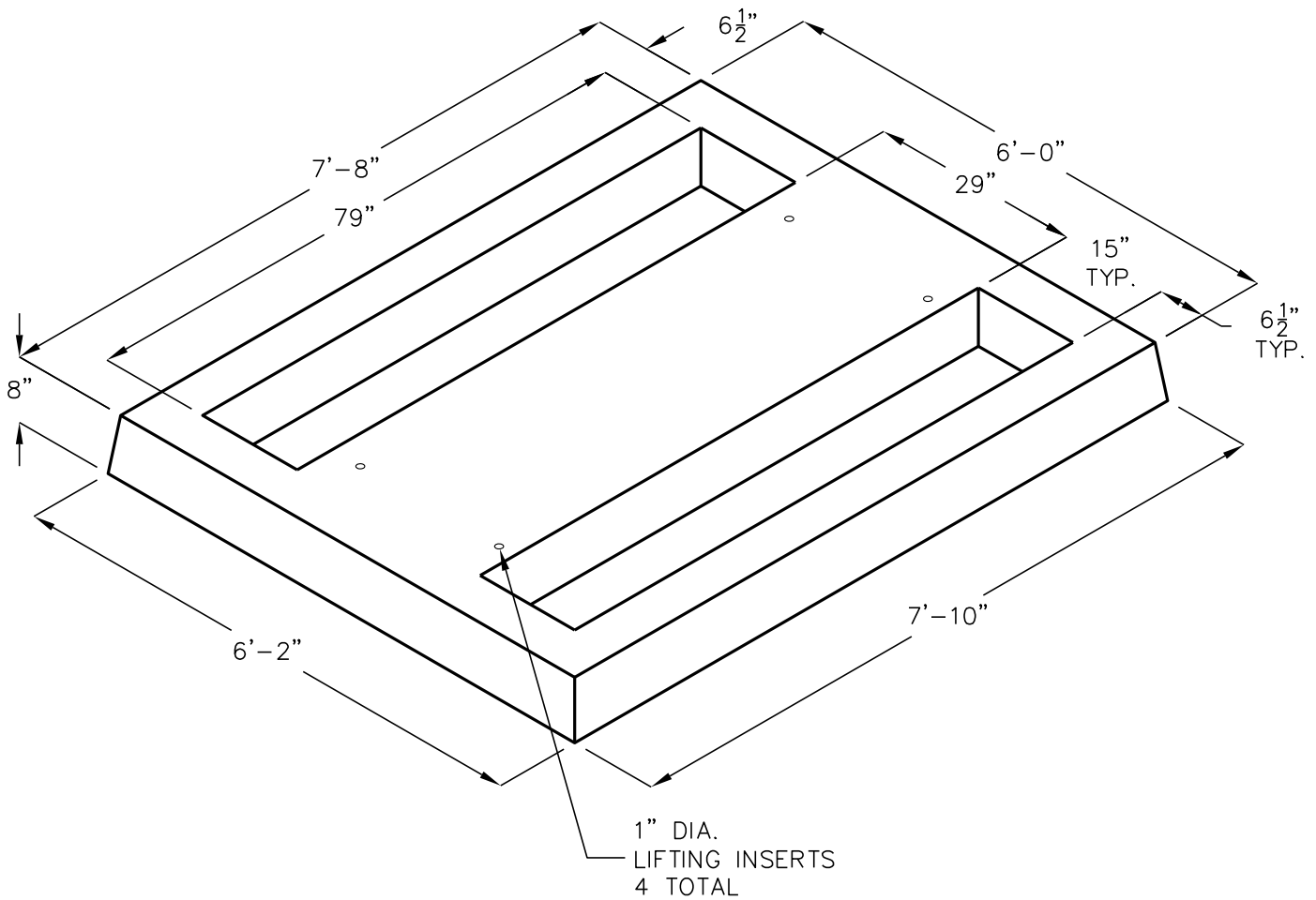

FOR COMPLETE DESIGN AND PRODUCT INFORMATION CONTACT JENSEN PRECAST.