

# PAD MOUNTED SWITCH PAD MODEL 13-U

MEETS NV ENERGY SPECS.  
DRAWING NO. PE0013 U  
STOCK NO. 24-0728

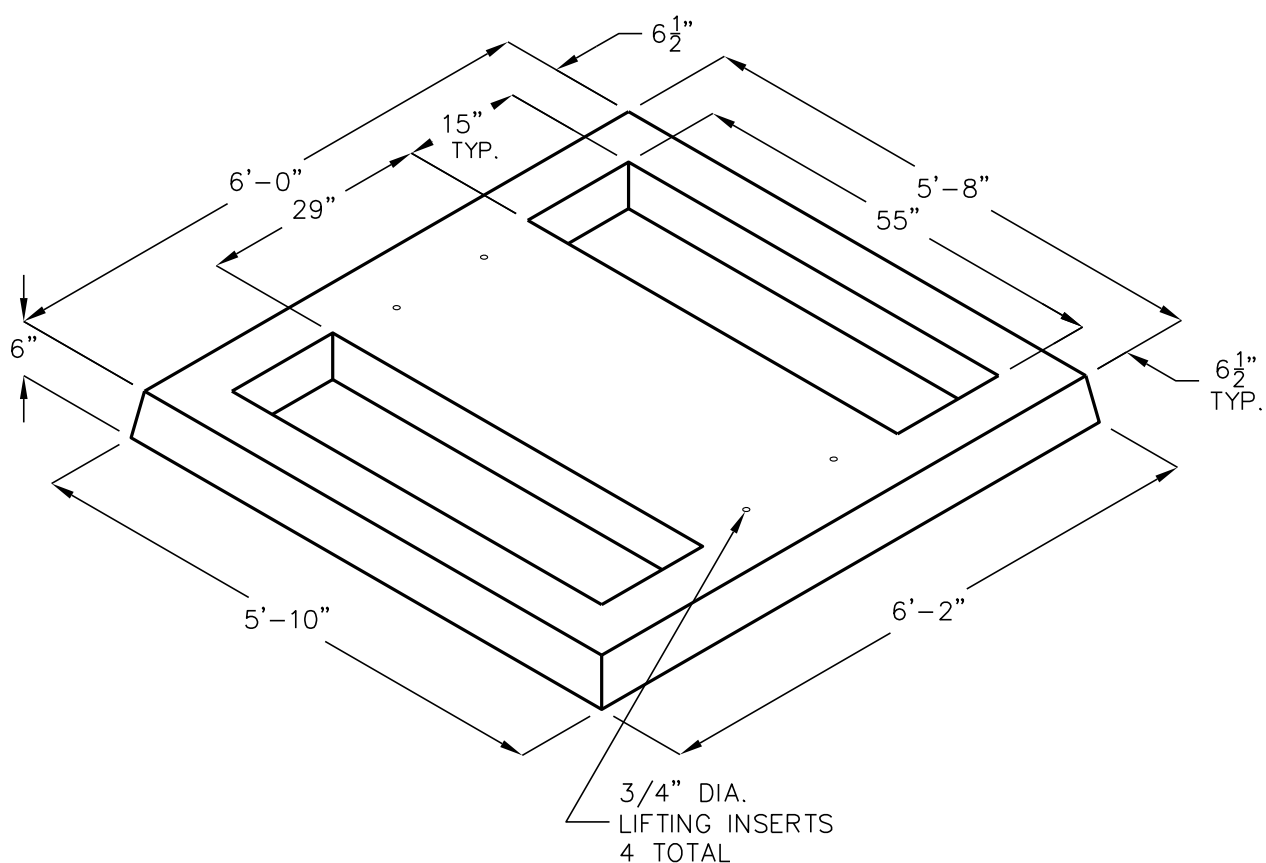

FOR COMPLETE DESIGN AND PRODUCT INFORMATION CONTACT JENSEN PRECAST.