

PAD MOUNTED SWITCH PAD MODEL 15-U

MEETS LIBERTY UTILITIES SPECS.
DRAWING NO. PE0015 U
STOCK NO. 24-0736

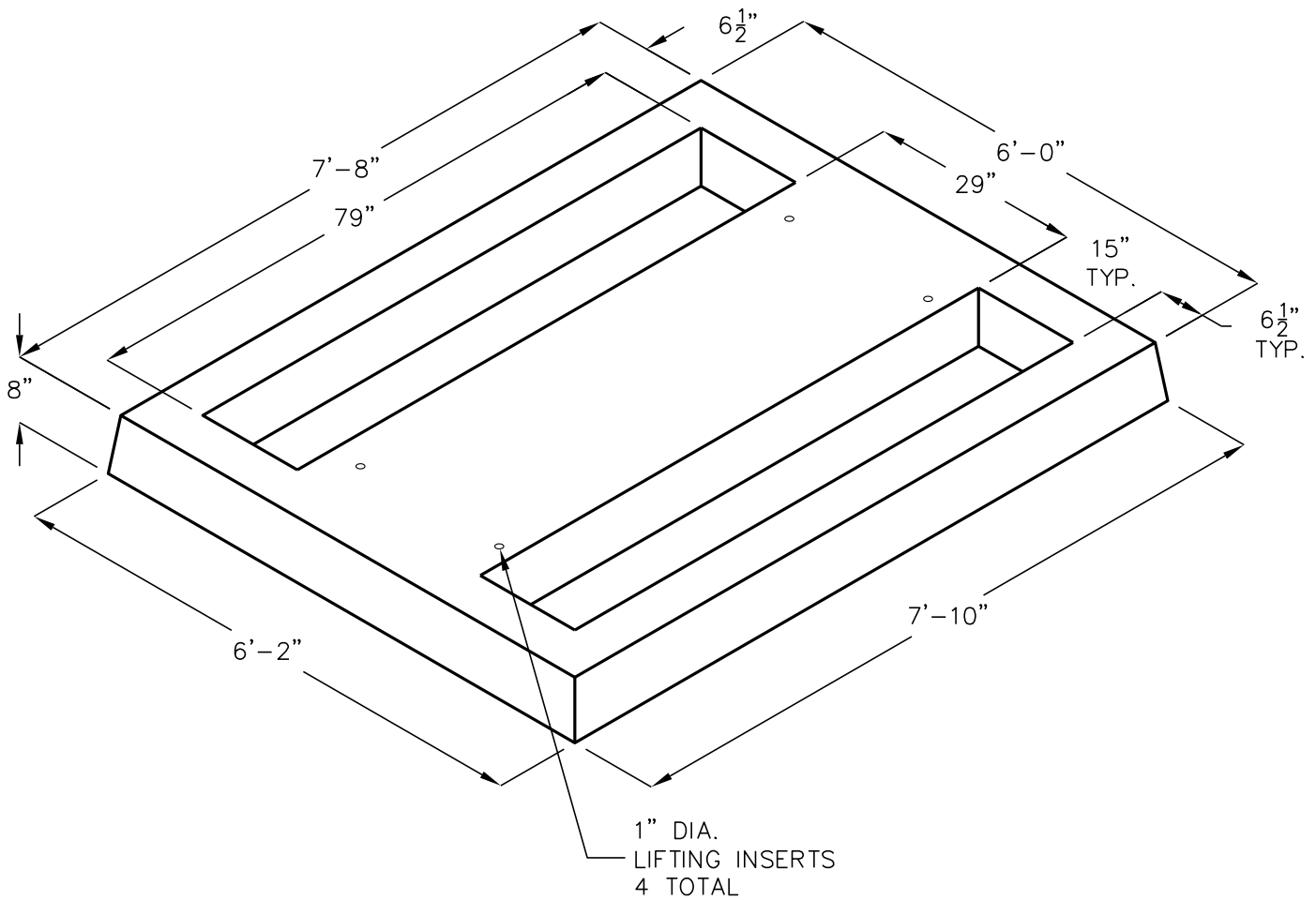

FOR COMPLETE DESIGN AND PRODUCT INFORMATION CONTACT JENSEN PRECAST.