

JS-3000 GALLON RESIDENTIAL SEPTIC TANK

MODEL JS3000

ACCEPTED BY UPC®

SIDE VIEW CUTAWAY

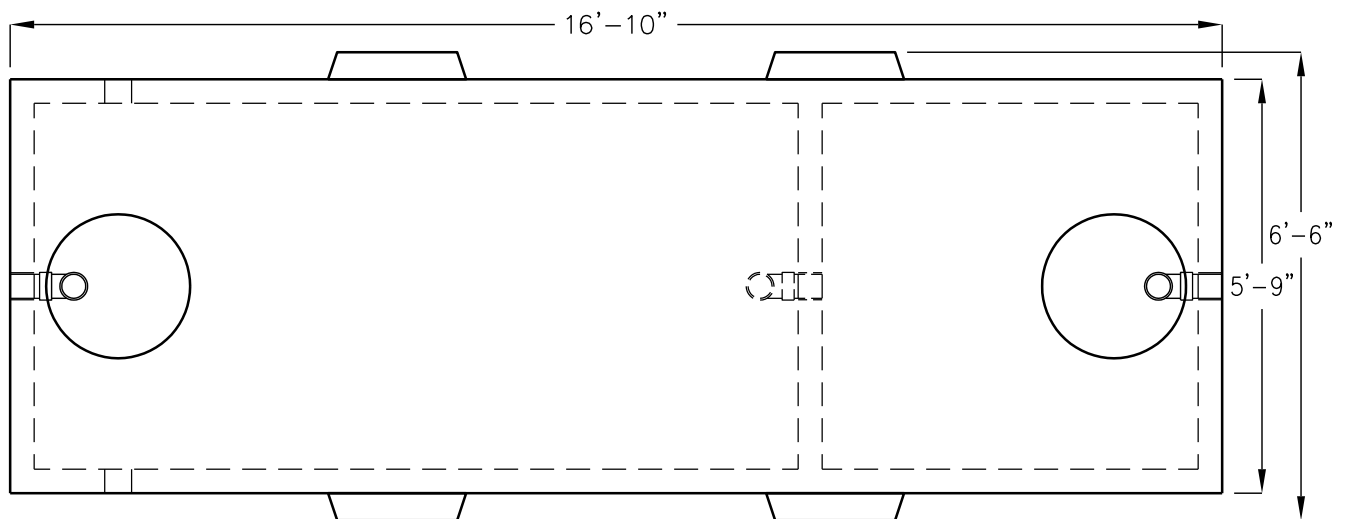
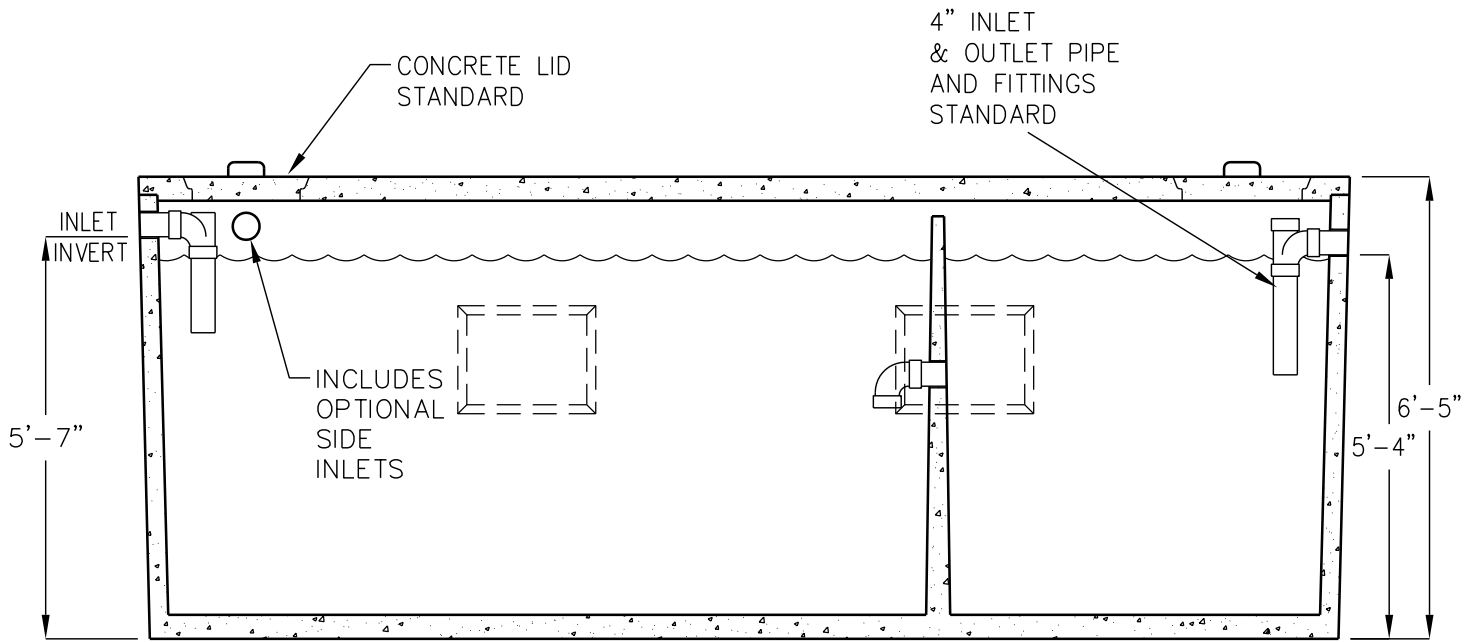

TOP VIEW

LIQUID CAPACITY: 3000 GALLONS
BOX DESIGN LOAD: NON-TRAFFIC, 3 FEET
OF SOIL COVER, MAXIMUM OF 500 PSF.

FOR COMPLETE DESIGN
AND PRODUCT INFORMATION
CONTACT JENSEN PRECAST.