

DOSING SIPHON TANK SERIES 1500T WITH 4" SIPHON

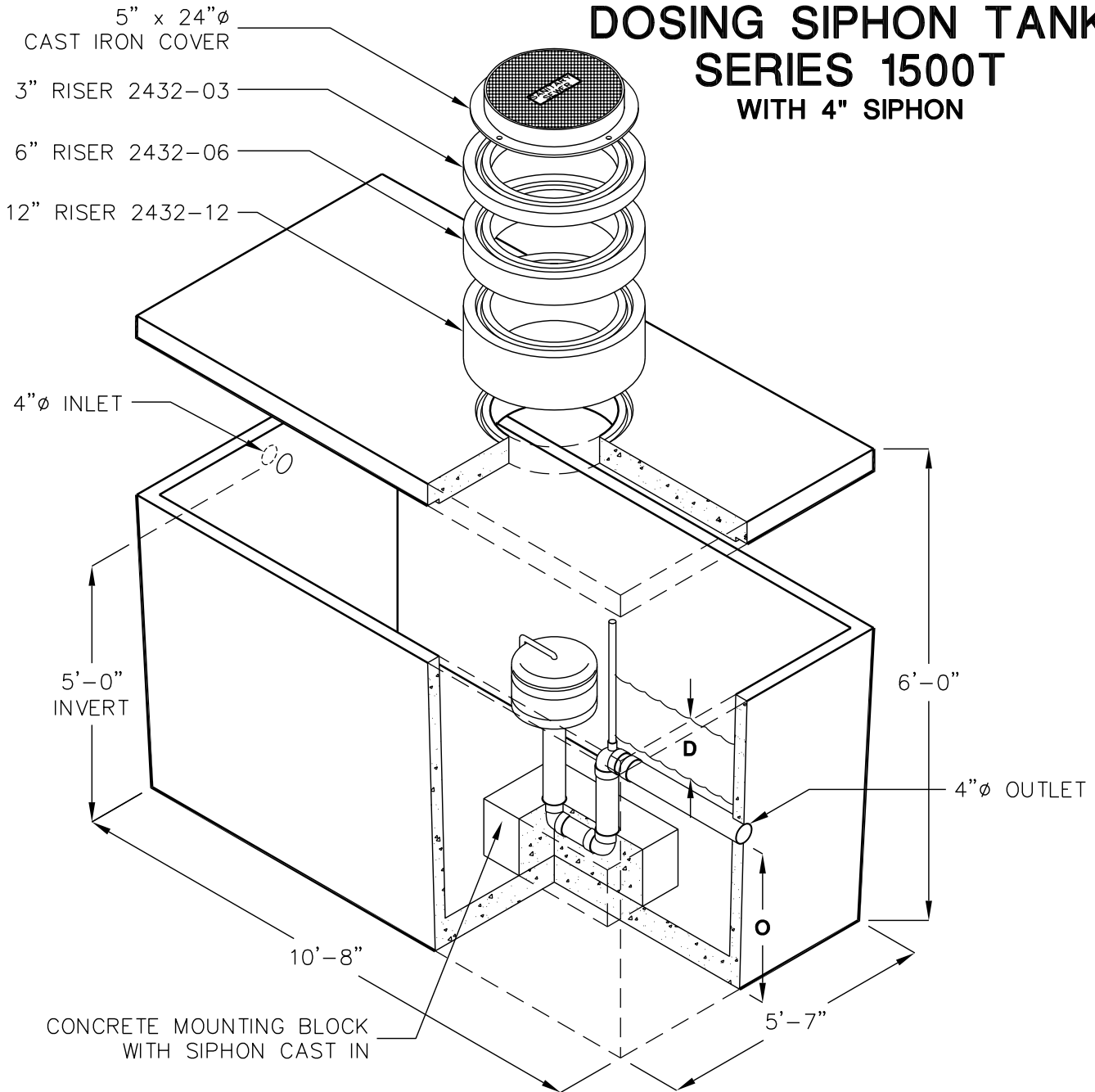

Dosing Siphon Tank Model No.	Average Discharge Flow (GPM)	Discharge Volume (Gallons)	Outlet Invert "O"	Draw Down "D"
DS1500-412	140	368	2'-11"	12"
DS1500-414	144	429	3'-2"	14"
DS1500-416	148	490	3'-0"	16"
DS1500-418	152	552	2'-10"	18"
DS1500-420	156	613	2'-7"	20"

DESIGN LOAD: H-20 TRAFFIC, 6' MAX. SOIL COVER, NON-TRAFFIC OPTION AVAILABLE.

FOR INFORMATION ON FILTER SCREENS AND DOSE COUNTERS SEE SIPHON ACCESSORIES PAGES.

FOR COMPLETE DESIGN AND PRODUCT INFORMATION CONTACT JENSEN PRECAST.