

1000 GALLON COMMERCIAL SEPTIC TANK

MODEL JP1000EE-ST
LISTED BY UPC®

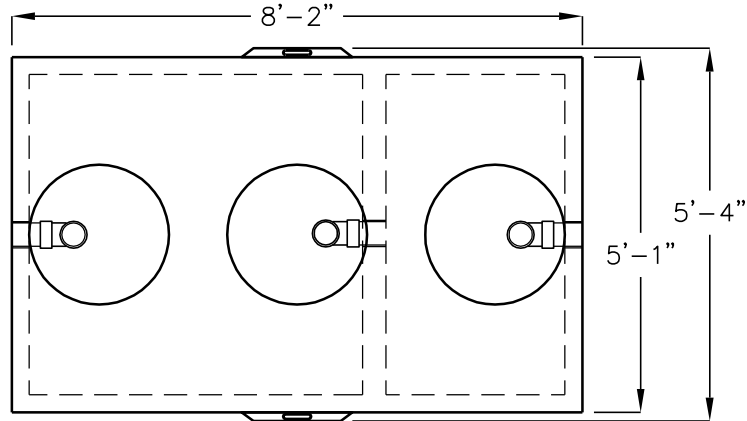

TOP VIEW
(COVERS & RINGS REMOVED)

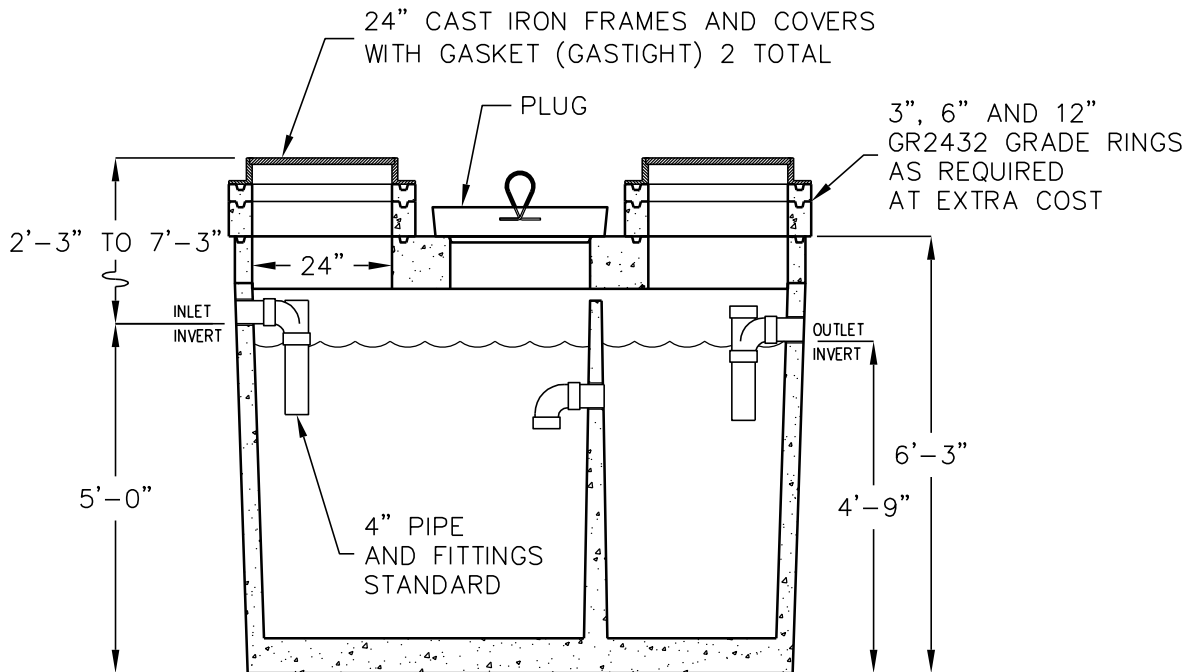

SIDE SECTION VIEW

OPERATING CAPACITY: 1,000 GALLONS.

DESIGN LOAD: H-20 TRAFFIC WITH DRY SOIL CONDITIONS
(WATER LEVEL BELOW TANK) AND 1'-6" EARTH COVER.

SUITABLE SUB-BASE BEDDED WITH GRANULAR MATERIAL SHALL BE
PREPARED TO HANDLE ANTICIPATED LOADS.

FOR COMPLETE DESIGN AND PRODUCT INFORMATION
CONTACT JENSEN PRECAST.

MINIMUM EXCAVATION
6'-4" x 9'-2"
x REQ'D DEPTH