

**1200 GALLON
CLARIFIER
MODEL JP1200ECE-CL
LISTED BY UPC®
NORTHERN CALIFORNIA**

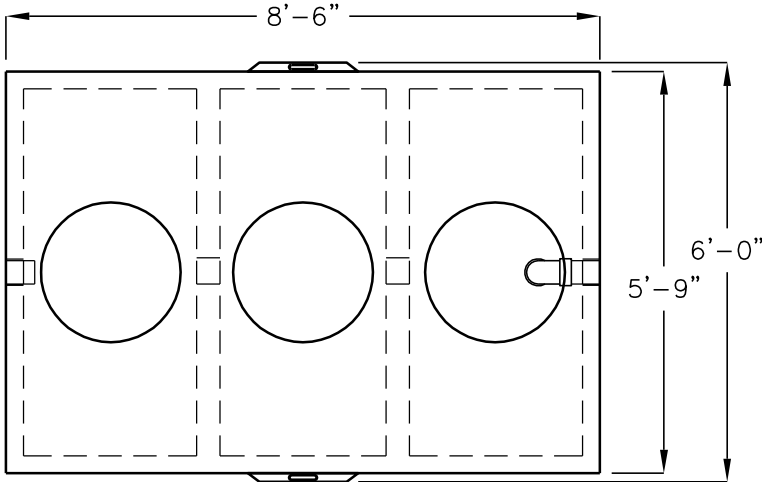

TOP VIEW
(COVERS & RINGS REMOVED)

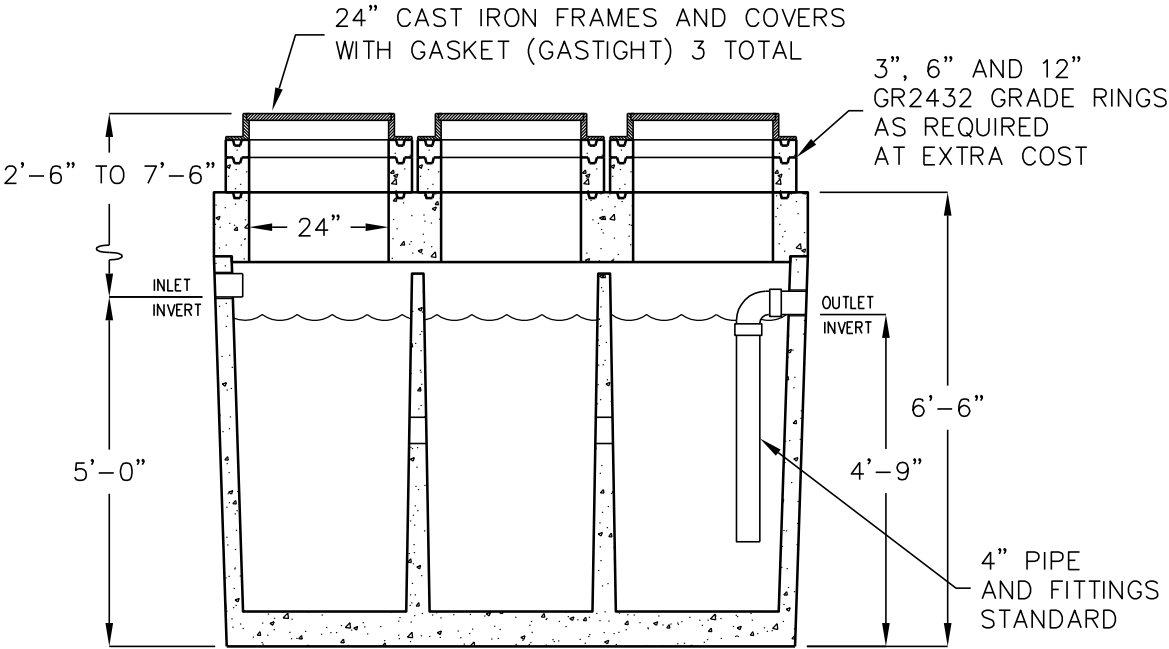

SIDE SECTION VIEW

OPERATING CAPACITY: 1,200 GALLONS.

DESIGN LOAD: H-20 TRAFFIC WITH DRY SOIL CONDITIONS (WATER LEVEL BELOW TANK) AND 1'-6' EARTH COVER.

SUITABLE SUB-BASE BEDDED WITH GRANULAR MATERIAL SHALL BE PREPARED TO HANDLE ANTICIPATED LOADS.

FOR COMPLETE DESIGN AND PRODUCT INFORMATION CONTACT JENSEN PRECAST.

MINIMUM EXCAVATION
7'-0" x 9'-6"
x REQ'D DEPTH