

615-12 MANHOLE

FRONTIER COMMUNICATIONS
6'-0" X 15'-0" X 12'-0" I.D.
(NOMINAL DIMENSIONS)

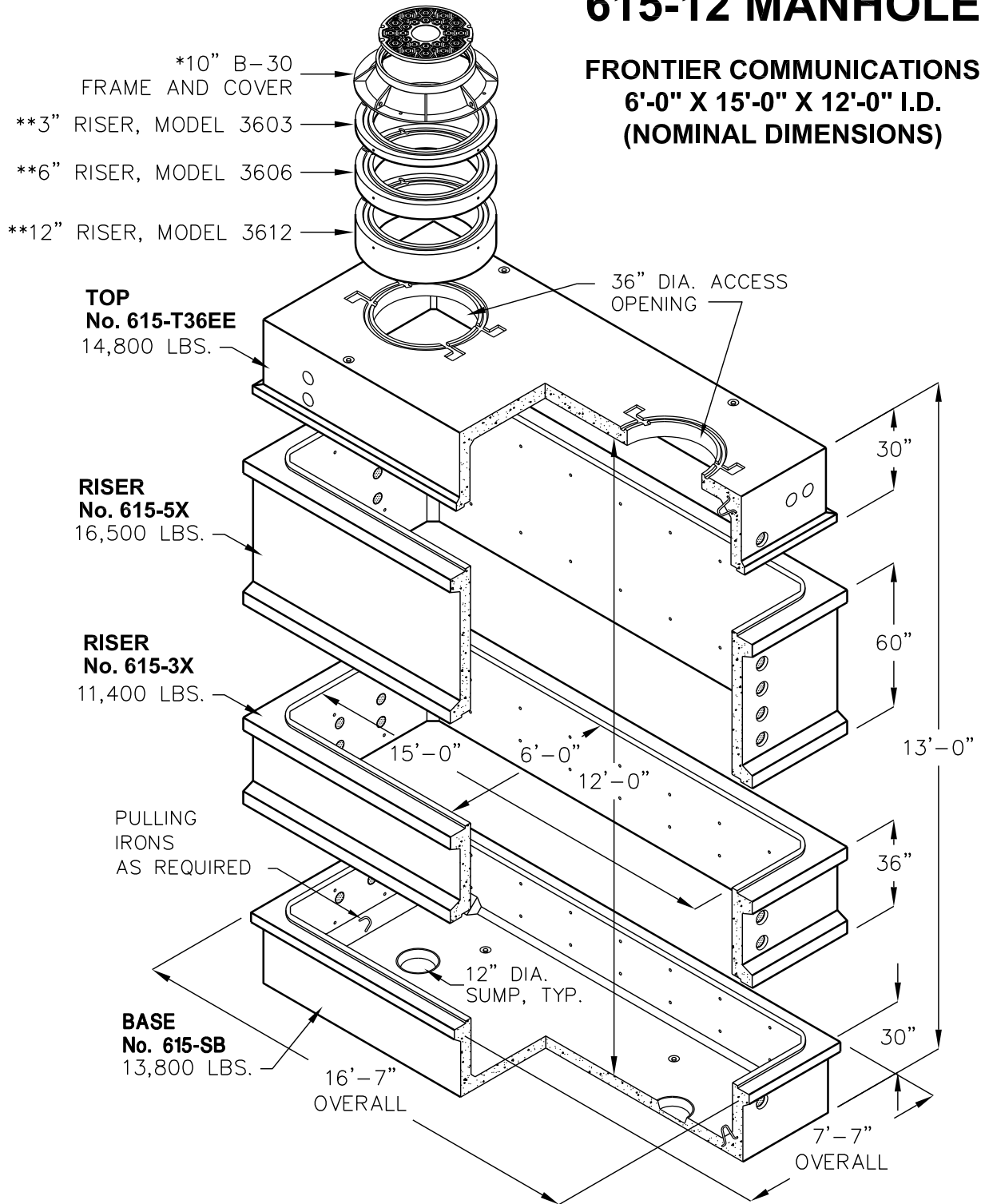

* SEE HARDWARE/APPURTENANCES SECTION FOR SPECIFICATIONS.
** RISERS OPTIONAL. SEE COLLAR/RISER SECTION FOR SPECIFICATIONS.

KNOCKOUTS, DUCT TERMINATORS, RACKING, AND LADDER PER CURRENT FRONTIER COMMUNICATIONS SPECIFICATIONS.

DESIGN LOAD: H-20 TRAFFIC WITH 1' TO 5' EARTH COVER.

FOR COMPLETE DESIGN AND PRODUCT INFORMATION, CONTACT JENSEN PRECAST.