

1500 GALLON RESIDENTIAL SEPTIC TANK

MODEL JS1500

ACCEPTED BY UPC®

**SIDE VIEW
CUTAWAY**

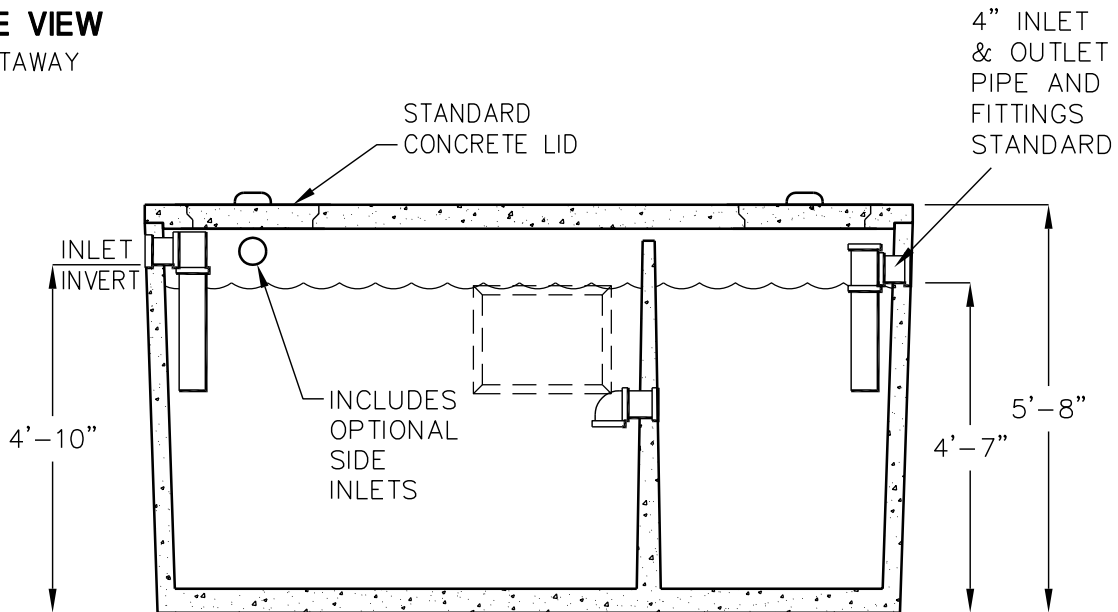

TOP VIEW

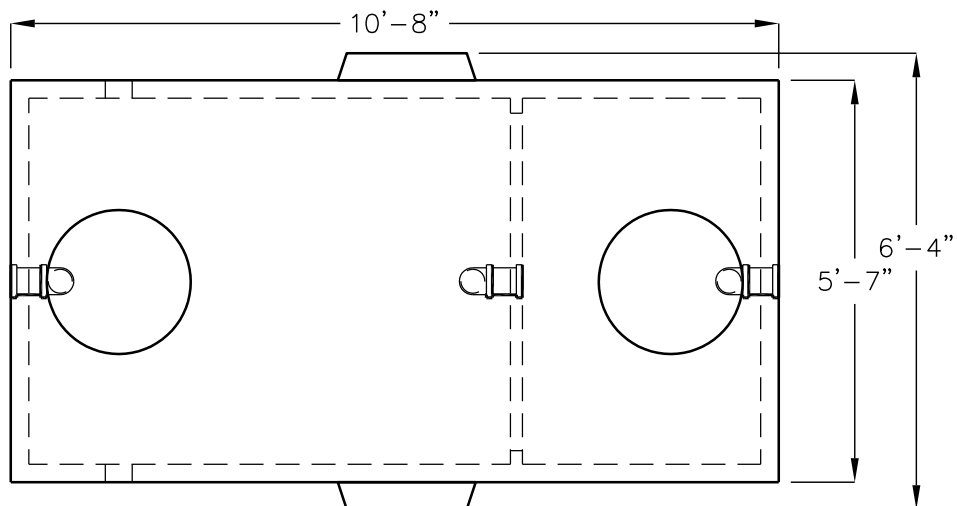

LIQUID CAPACITY: 1500 GALLONS
BOX DESIGN LOAD: NON-TRAFFIC, UP TO 3 FEET
OF SOIL COVER, MAXIMUM 500 PSF.

FOR COMPLETE DESIGN
AND PRODUCT INFORMATION
CONTACT JENSEN PRECAST.