

1200 GALLON SAND-OIL INTERCEPTOR

MODEL JP1200SO

TRAFFIC RATED ACCEPTED BY UPC.

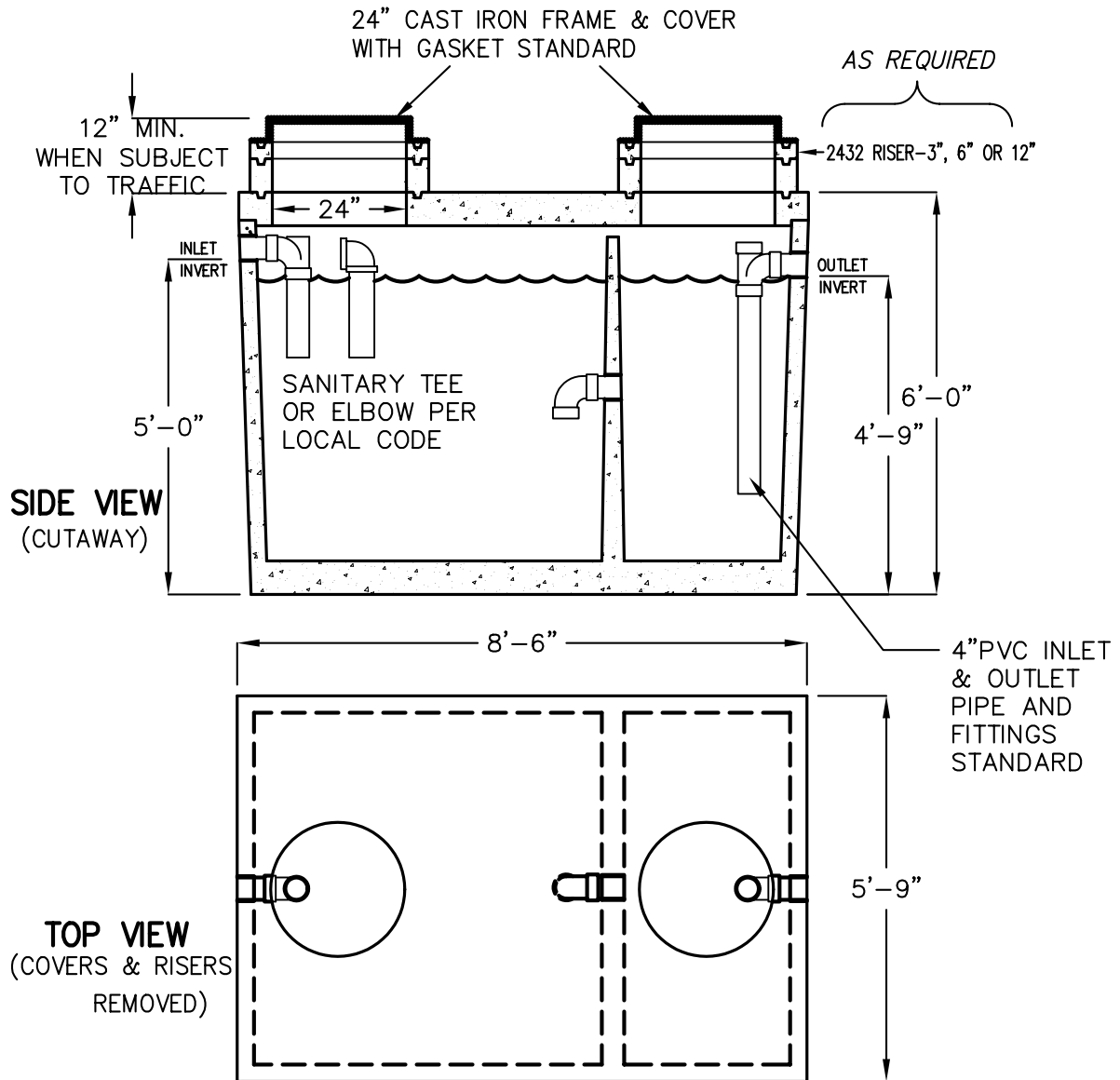

- LIQUID CAPACITY: 1,200 GALLONS.
- TANK DESIGNED FOR H-20 TRAFFIC WHEEL LOAD WITH DRY SOIL CONDITIONS (WATER TABLE BELOW TANK) EARTH COVER OVER TANK NOT TO EXCEED 6 FT.
- SUITABLE NATIVE OR SUB-BASE SHALL BE PREPARED TO HANDLE ANTICIPATED LOADS. THE EXCAVATION SHALL BE BEDDED WITH SUITABLE GRANULAR MATERIAL AND SHALL BE COMPACTED TO 90% MAXIMUM DRY DENSITY, OR TO REQUIREMENTS OF THE PROJECT GEOTECHNICAL ENGINEER.
- FOR COMPLETE DESIGN AND PRODUCT INFORMATION CONTACT JENSEN PRECAST.

MINIMUM EXCAVATION SIZE:
6'-9" X 9'-6" X DEPTH REQ'D.

THE DESIGN AND DETAIL OF THIS DRAWING ARE THE PROPERTY OF JENSEN PRECAST AND NOT TO BE USED EXCEPT IN CONNECTION WITH ITS OWN WORK. DESIGN AND INVENTION RIGHTS ARE RESERVED.