

500 GALLON GREASE INTERCEPTOR

MODEL JP500-EE-G
TRAFFIC RATED

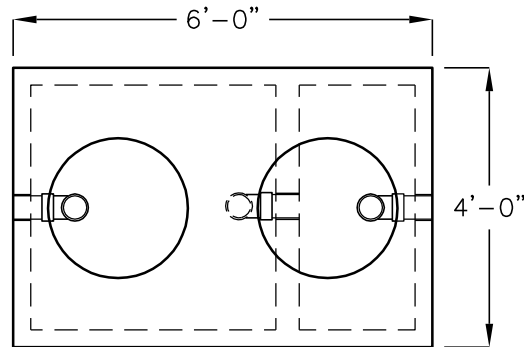

TOP VIEW
(COVERS & RINGS REMOVED)

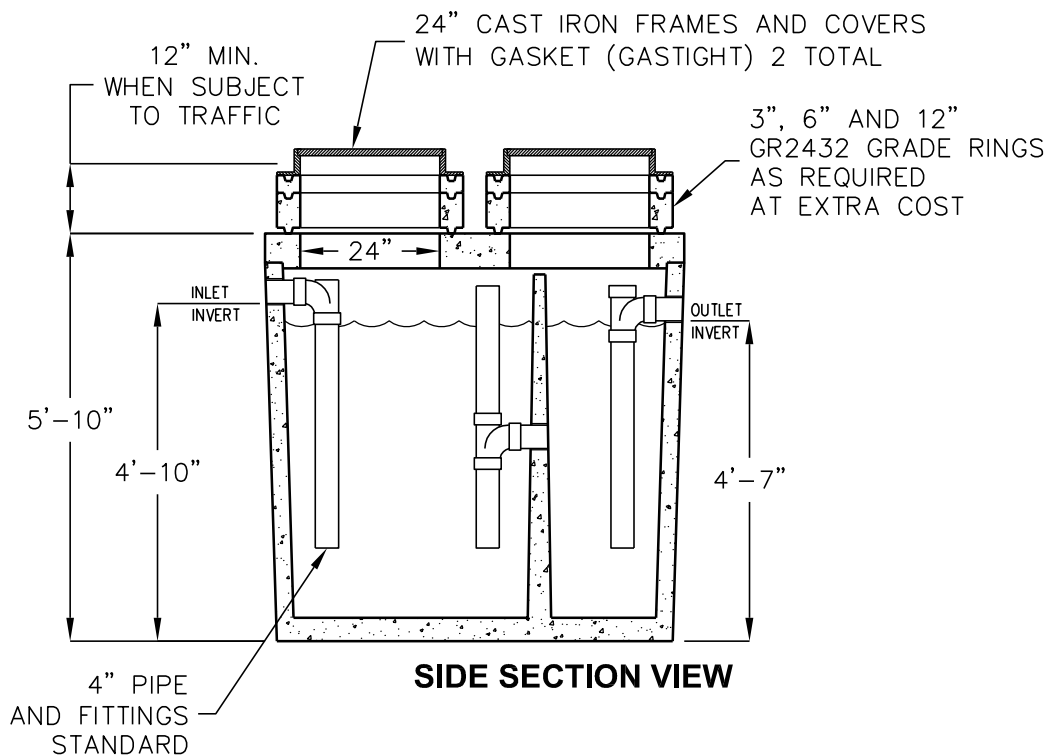

SIDE SECTION VIEW

OPERATING CAPACITY: 500 GALLONS.

DESIGN LOAD: H-20 TRAFFIC WITH DRY SOIL CONDITIONS (WATER LEVEL BELOW TANK) AND 1 TO 6 FEET EARTH COVER.

BEDDING NOTE: SUITABLE SUB-BASE BEDDED WITH GRANULAR MATERIAL SHALL BE PREPARED TO HANDLE ANTICIPATED LOADS.

FOR COMPLETE DESIGN AND PRODUCT INFORMATION CONTACT JENSEN PRECAST.

MINIMUM EXCAVATION
5'-0" x 7'-0"
x REQ'D DEPTH

Jensen Precast reserves the right to make changes to product design and/or dimensions without notice. Please contact Jensen Precast whenever necessary for confirmation or advice on product design.

JENSEN
PRECAST