

24x36 HANDHOLE NON-CONCRETE

PG&E APPROVED. POLYMER CONCRETE FRAME AND NON-SKID COVER FOR STRENGTH. "FRP" FIBERGLASS REINFORCED BODY FOR LIGHT WEIGHT. FLARED AT BASE TO PROVIDE ADDITIONAL WORK SPACE. MEETS ALL REQUIREMENTS OF W.U.C..

24"x36"x26"
(INSIDE DIMENSIONS)

PG&E #04-0942

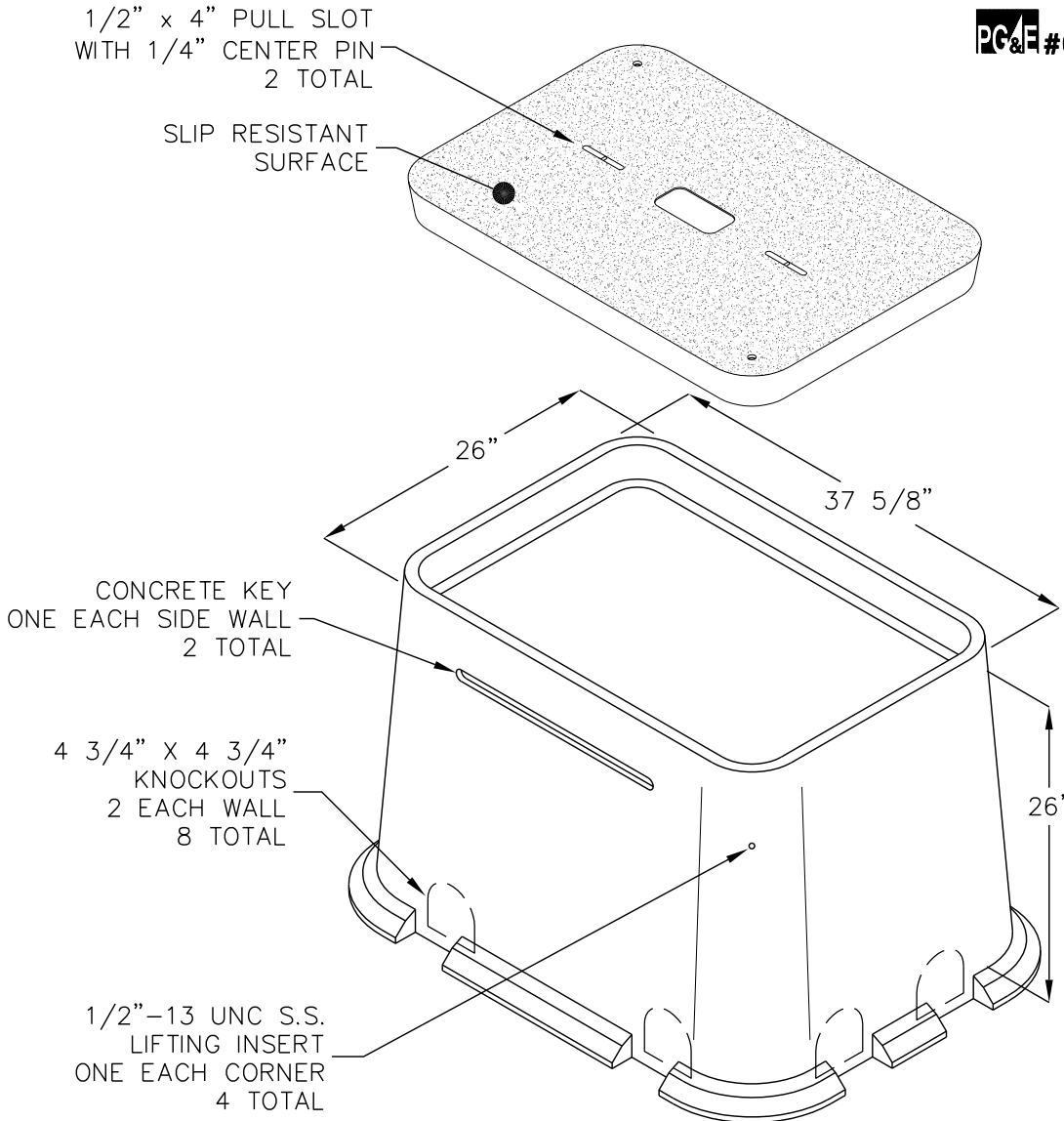

NOMINAL DIMENSIONS	PG&E CODE NO.	DESCRIPTION	APPROX. WT. LBS.
24"x36"x26"	04-0942	BOX AND COVER ASSEMBLY	300
24"x36"x26"	04-0919	BOX ONLY	200
24"x36"x4"	04-0118	4" EXTENSION	90
	04-3724	LID ONLY	100

DESIGN LOAD: STATIC DESIGN LOAD OF 8000 LBS.
OVER A 10" X 10" AREA.

FOR COMPLETE DESIGN AND PRODUCT INFORMATION
CONTACT JENSEN PRECAST.

4/25/06
243626HH_PGE_B.dwg
© 2006 Jensen Precast

JENSEN
PRECAST