

# 17x30 HANDHOLE NON-CONCRETE

PG&E APPROVED. POLYMER CONCRETE FRAME AND NON-SKID COVER FOR STRENGTH. "FRP" FIBERGLASS REINFORCED BODY FOR LIGHT WEIGHT. FLARED AT BASE TO PROVIDE ADDITIONAL WORK SPACE. MEETS ALL REQUIREMENTS OF W.U.C..

17"x30"x18"  
(INSIDE DIMENSIONS).

**PG&E** #04-0936

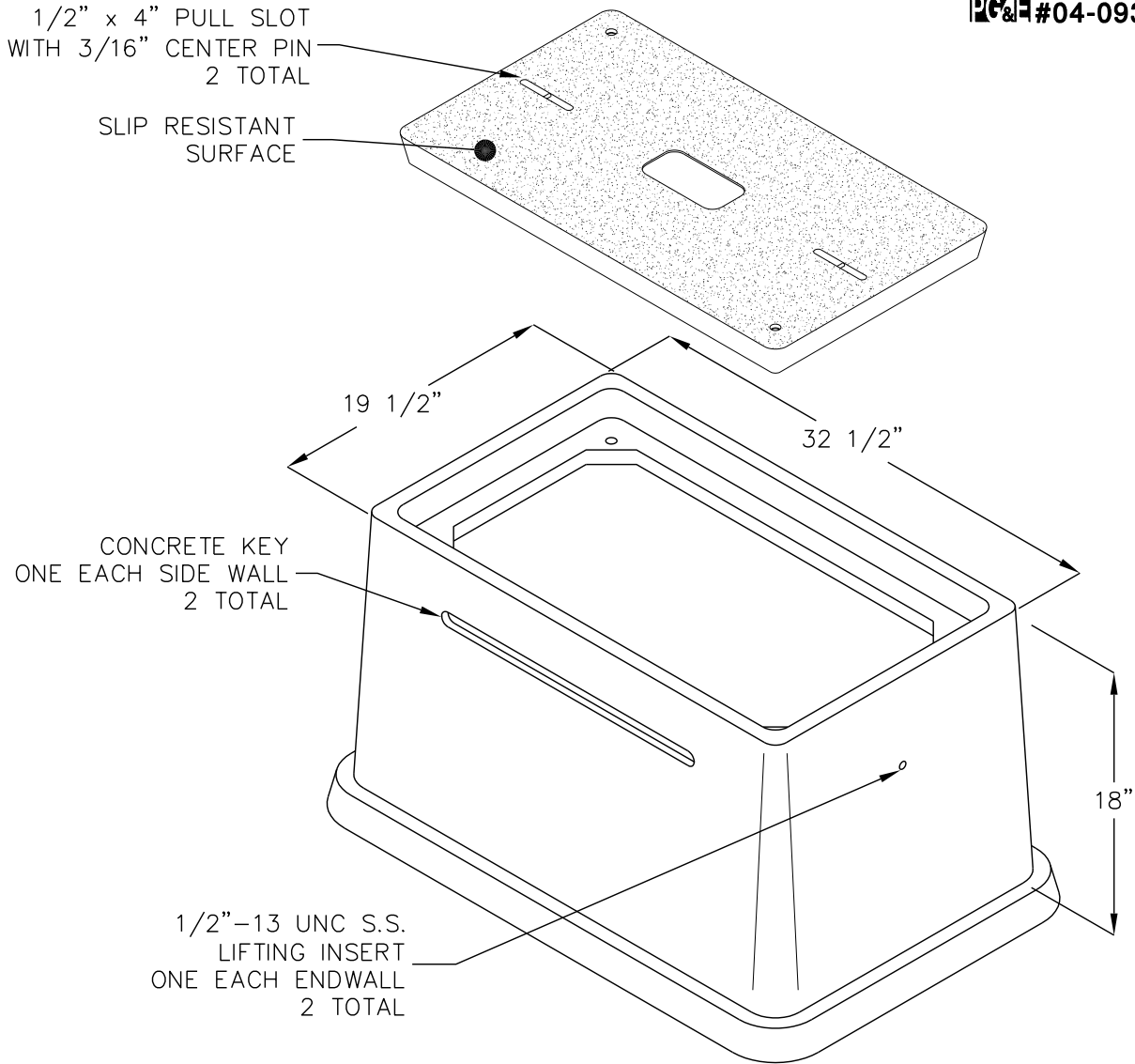

NOMINAL DIMENSIONS	PG&E CODE NO.	DESCRIPTION	APPROX. WT. LBS.
17"x30"x18"	04-0936	BOX AND COVER ASSEMBLY	184
17"x30"x18"	04-0928	BOX ONLY	132
17"x30"x3"	04-0117	3" EXTENSIONS	47
	04-3720	LID ONLY	52

DESIGN LOAD: STATIC DESIGN LOAD OF 8000 LBS. OVER A 10" X 10" AREA.

FOR COMPLETE DESIGN AND PRODUCT INFORMATION CONTACT JENSEN PRECAST.