

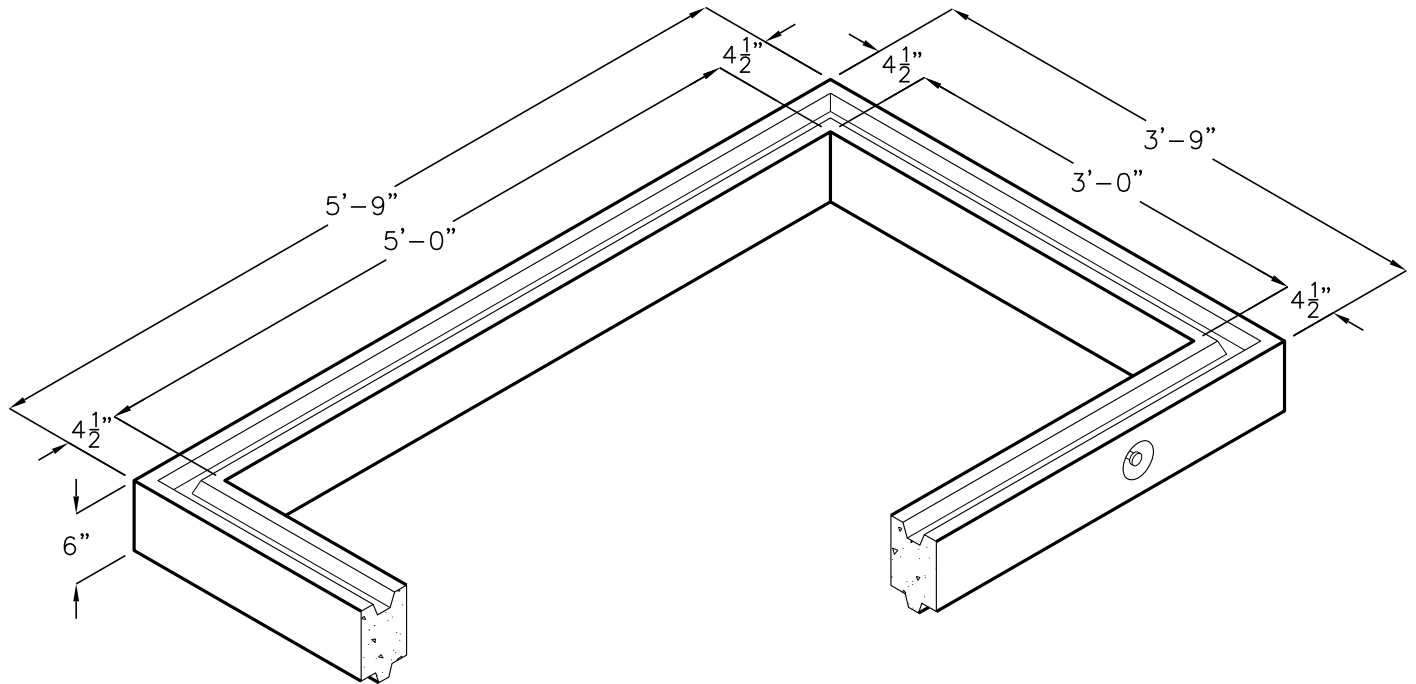

at&t Northern California
Nevada

3'-0"x5'-0"x6" AT&T SUB-SURFACE ENCLOSURE EXTENSION

AT&T OIN: 100061963



WEIGHT: 480 LBS

F 8/17/2015 RS3506.DWG ©2015

JENSEN
PRECAST EST. 1968

Jensen Precast reserves the right to make changes to product design and/or dimensions without notice. Please contact Jensen Precast whenever necessary for confirmation or advice on product design.