

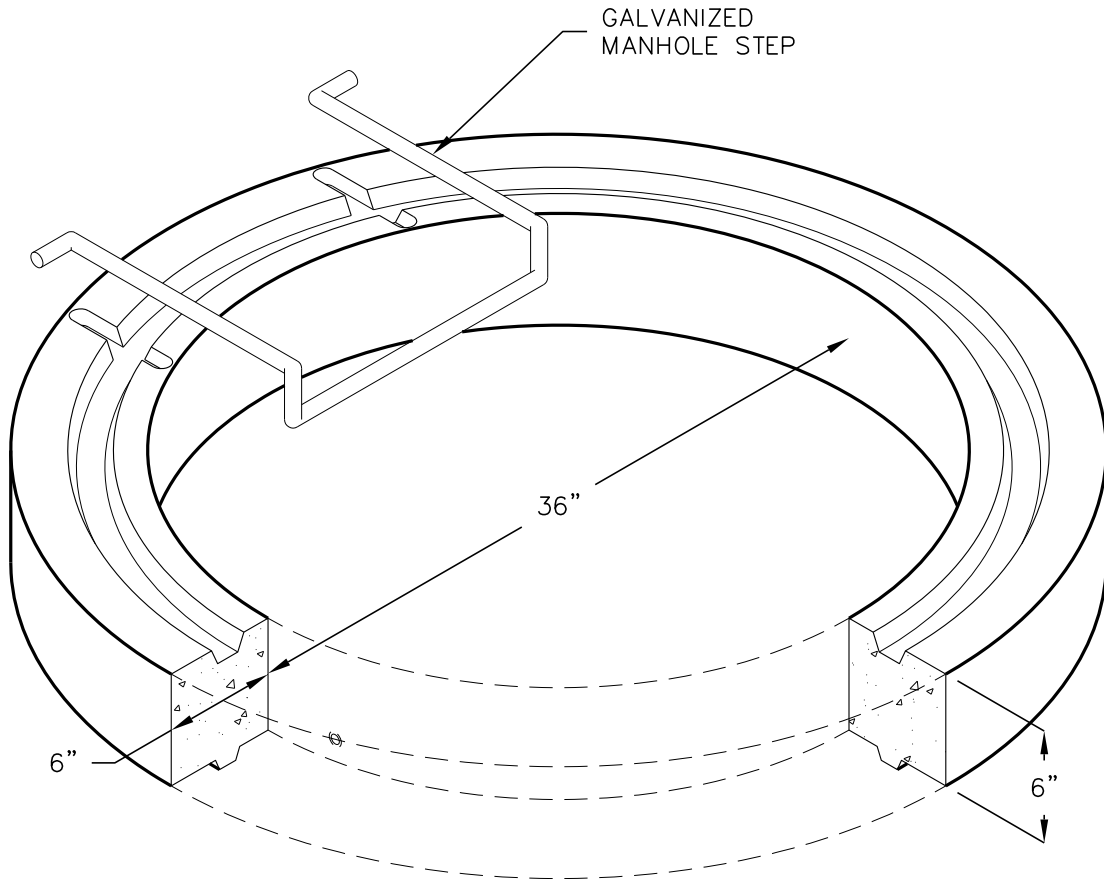

at&t Northern California
Nevada

36" INSIDE DIAMETER x6" AT&T GRADE RING

AT&T OIN: 100061925



MATERIAL LIST	
DESCRIPTION	WEIGHT (LBS)
36"x6" GRADE RING	399
GALVANIZED MANHOLE STEP	7

JENSEN
PRECAST EST. 1968

Jensen Precast reserves the right to make changes to product design and/or dimensions without notice. Please contact Jensen Precast whenever necessary for confirmation or advice on product design.