

2436 PULLBOX

MODEL PB2436

24" WD. x 36" LG. x 38" H.
(INSIDE DIMENSIONS)

STANDARD DROP-IN ADJUSTABLE COVERS			
MODEL NO.	A	DESIGN LOAD	WEIGHT
CA2436AI	3"	INCIDENTAL H-20	244 LBS.
CA2436AP	3"	PEDESTRIAN	210 LBS.

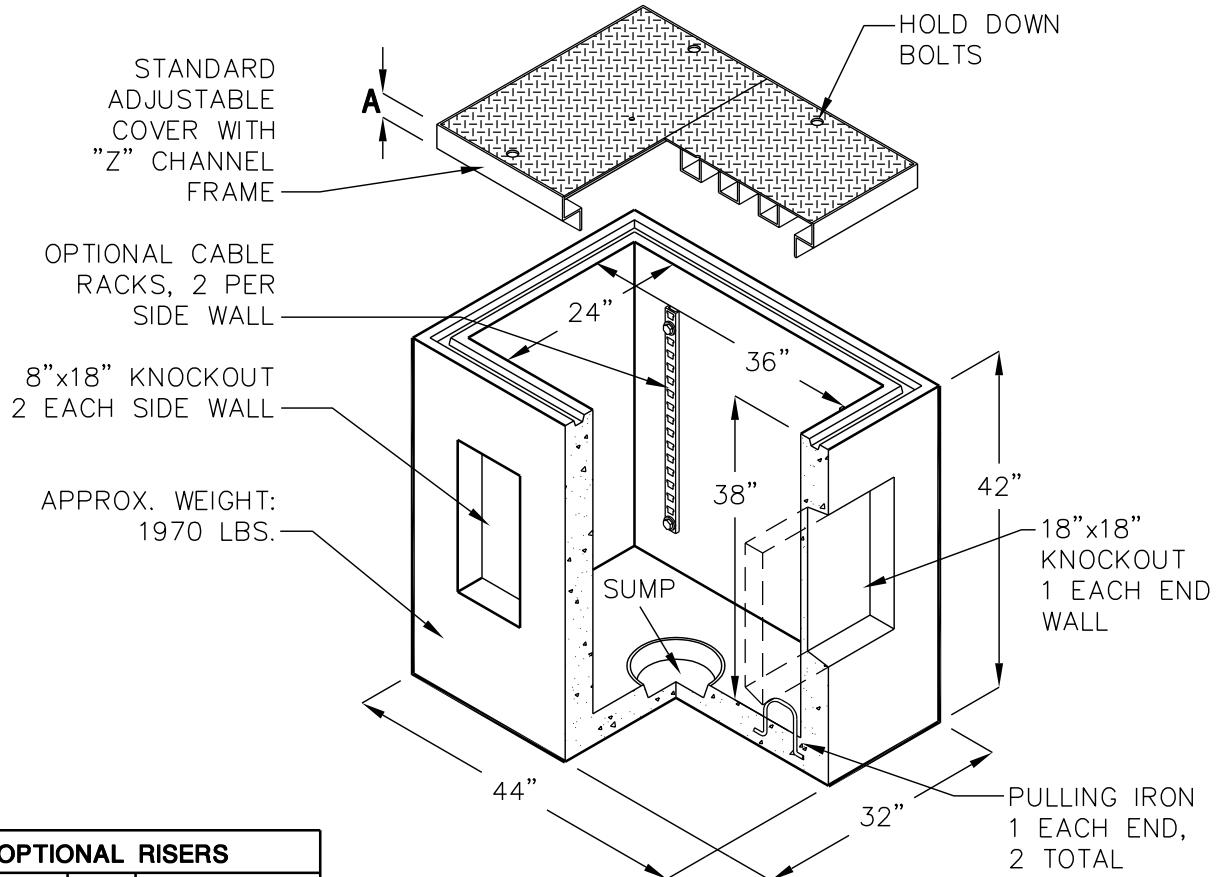

OPTIONAL RISERS		
MODEL NO.	B	WEIGHT
RS243606	6"	450 LBS.
RS243612	12"	900 LBS.

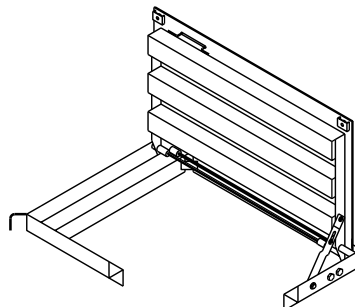
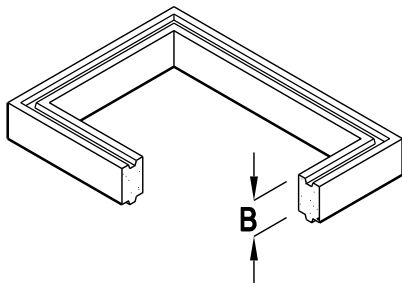

ADJUSTABLE TORSION SPRING ASSISTED COVERS (OPTIONAL)

CA2436ATI, 244 LBS.
DESIGN LOAD:
INCIDENTAL H-20 OR
CA2436ATP, 210 LBS.
DESIGN LOAD:
PEDESTRIAN

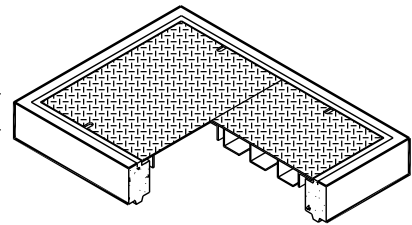

NON ADJUSTABLE CAST-IN COVERS (OPTIONAL)

CA2436C6I, 541 LBS.
DESIGN LOAD:
INCIDENTAL H-20 OR
CA2436C6P, 497 LBS.
DESIGN LOAD:
PEDESTRIAN

FOR COMPLETE DESIGN AND PRODUCT INFORMATION, CONTACT JENSEN PRECAST.