

DROP INLET

24"x24" I.D.
(NOMINAL DIMENSIONS)
WITH FRAME AND GRATE

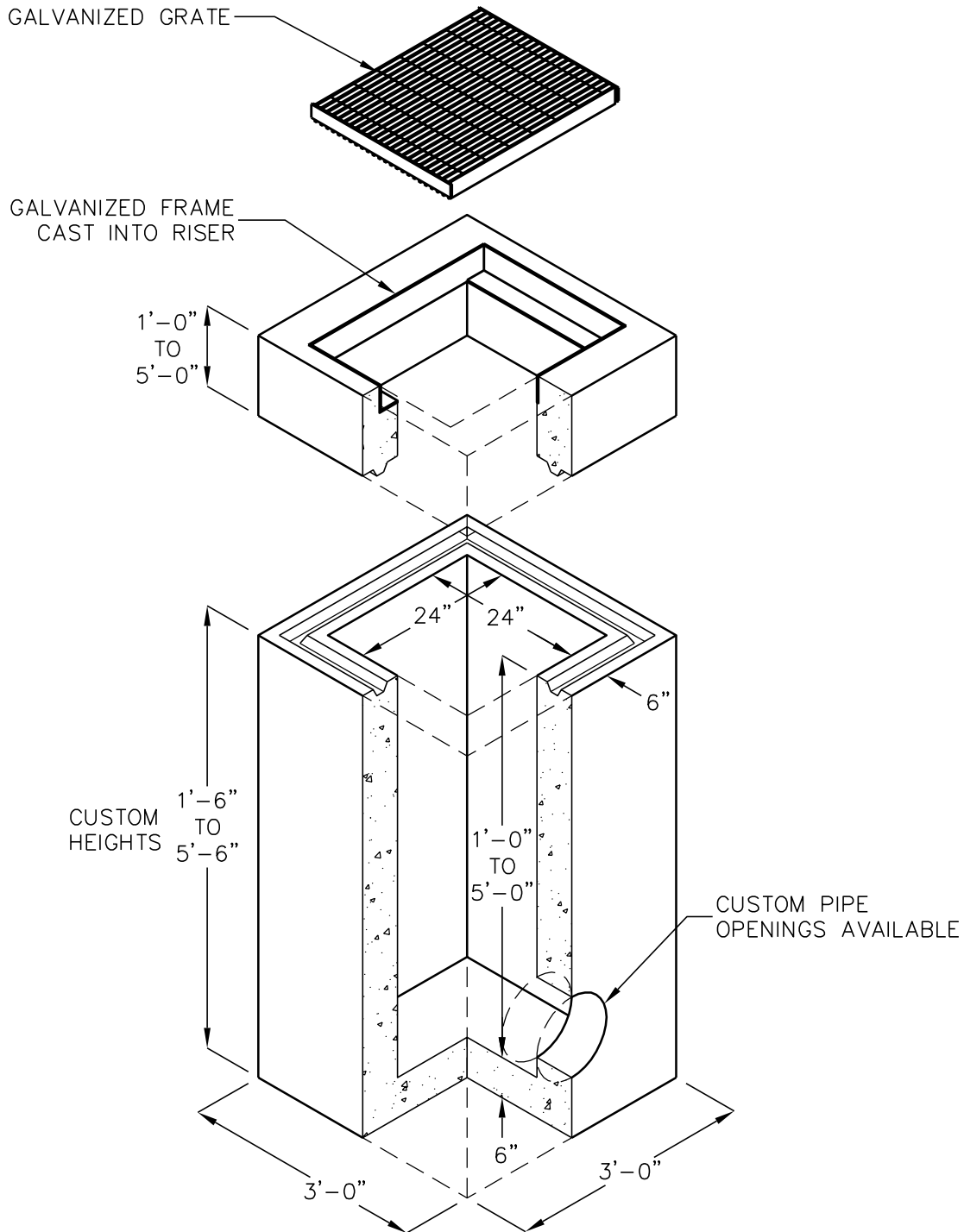

FOR COMPLETE DESIGN AND PRODUCT INFORMATION
CONTACT JENSEN PRECAST.