

12,000 GALLON BATTERY GREASE INTERCEPTOR MODEL 3XJZ4000-G

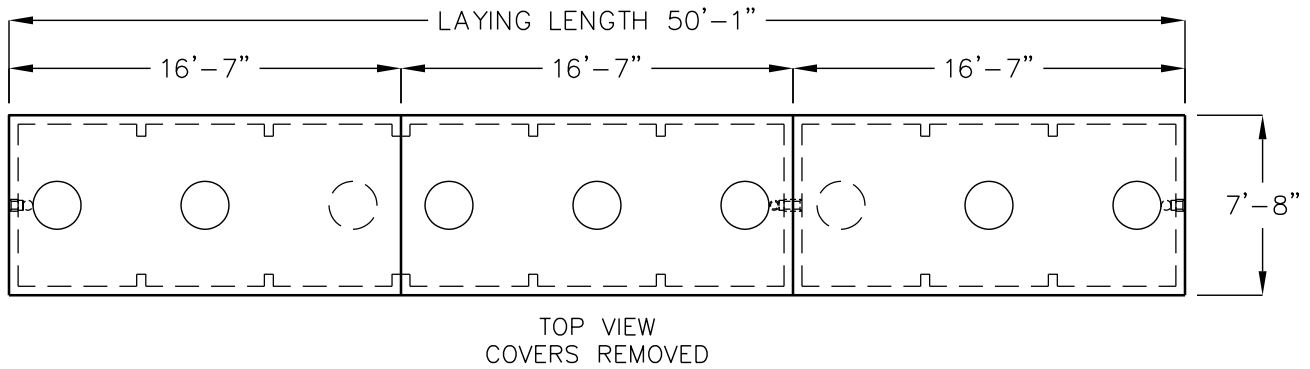
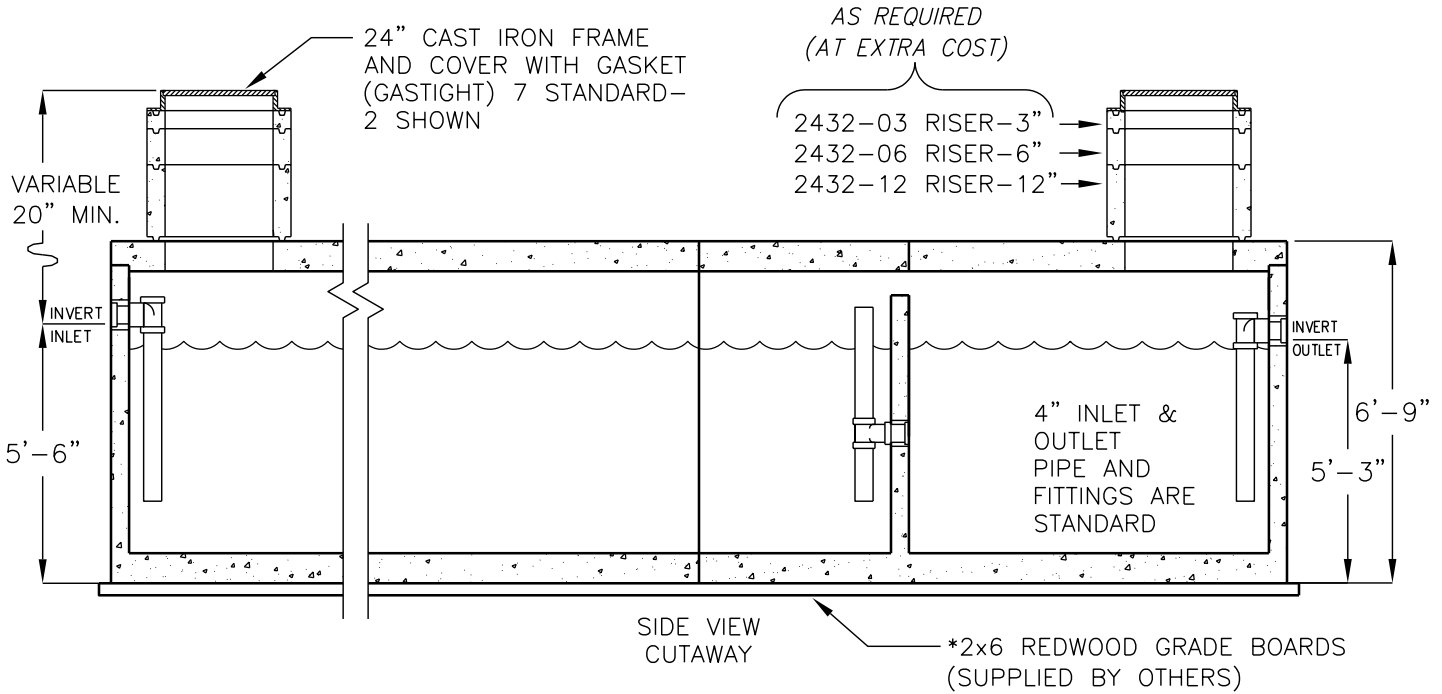

○ = RECOMMENDED
RISER/CAST IRON
COVER LOCATIONS

○ = OPTIONAL
RISER/CAST IRON
COVER LOCATIONS

NOTE: DISTANCE BETWEEN
ACCESS OPENINGS DOES
NOT EXCEED 10'.

FOR INSTALLATION INSTRUCTIONS,
DESIGN AND PRODUCT INFORMATION,
CONTACT JENSEN PRECAST.

LIQUID CAPACITY: 12,000 GALLONS.
BOX DESIGN LOAD: H-20 TRAFFIC FROM
1' TO 5' OF SOIL COVER.