

1200 GALLON RESIDENTIAL SEPTIC TANK

MODEL JS1200
ACCEPTED BY UPC®

**SIDE VIEW
CUTAWAY**

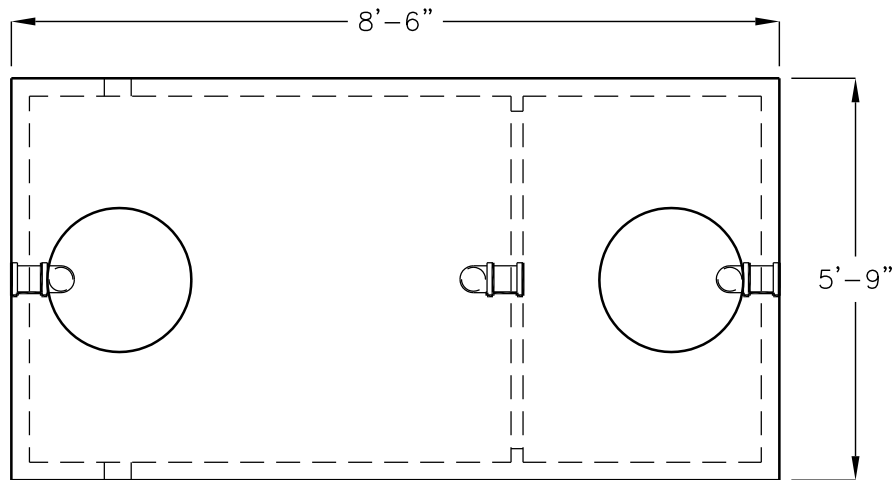
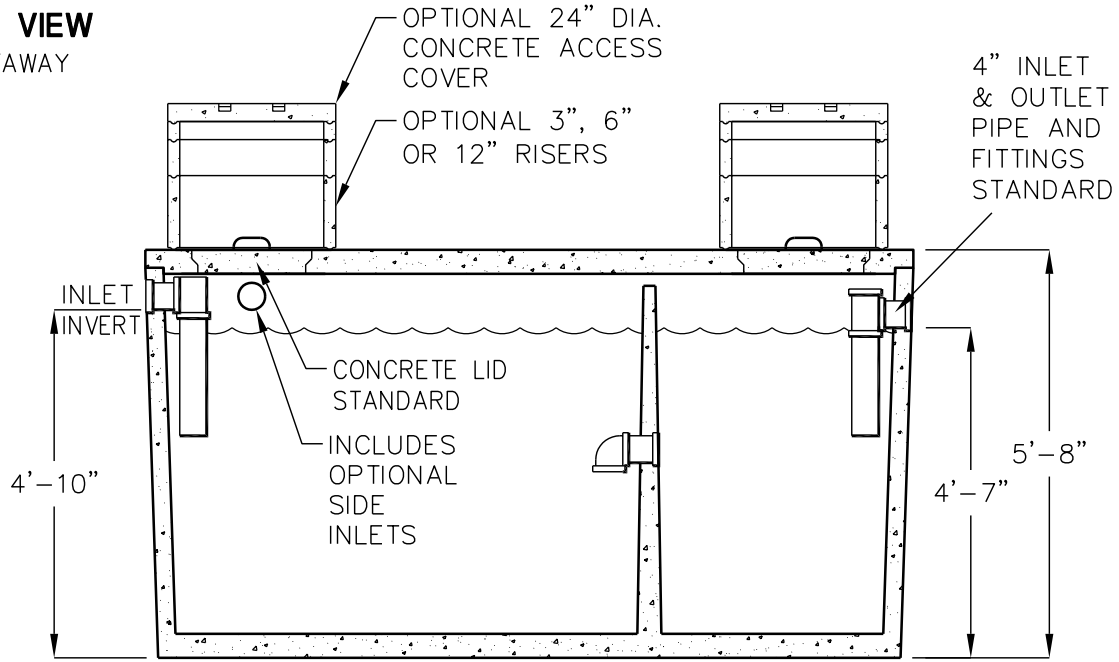

TOP VIEW

LIQUID CAPACITY: 1200 GALLONS
BOX DESIGN LOAD: NON-TRAFFIC, UP TO 3 FEET
OF SOIL COVER, MAXIMUM 500 PSF.

FOR COMPLETE DESIGN
AND PRODUCT INFORMATION
CONTACT JENSEN PRECAST.