

HIGH CAPACITY CURB INLET 7272-X4

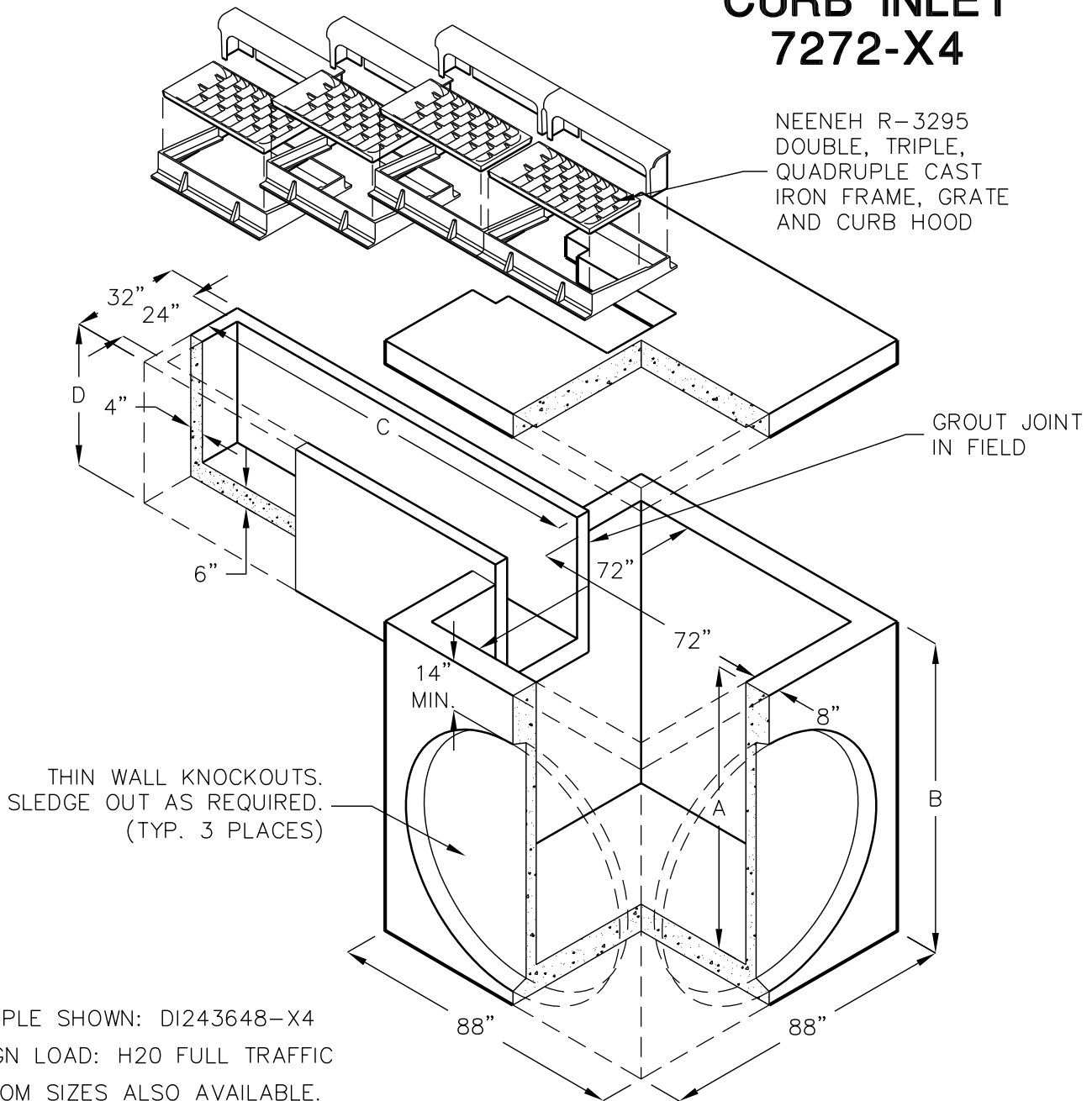

EXAMPLE SHOWN: DI243648-X4
 DESIGN LOAD: H2O FULL TRAFFIC
 CUSTOM SIZES ALSO AVAILABLE.
 DIMENSION 'C' = VARIABLE AS REQUIRED.
 DIMENSION 'D' = VARIABLE UP TO 78" MAX (72" I.D.).

Model No.		Dimensions	
DI Model	Model Suffix	A	B
DI727248-	X2, X3, X4	48"	54"
DI727260-		60"	66"
DI727272-		72"	78"
DI727284-		84"	90"

Model Suffix	No. of Grates	Dimensions	
		C	D
X2	2	41 1/2"	36"
X3	3	79"	48"
X4	4	116 1/2"	60"

FOR COMPLETE DESIGN
AND PRODUCT INFORMATION,
CONTACT JENSEN PRECAST.