

HIGH CAPACITY CURB INLET 6060-X4

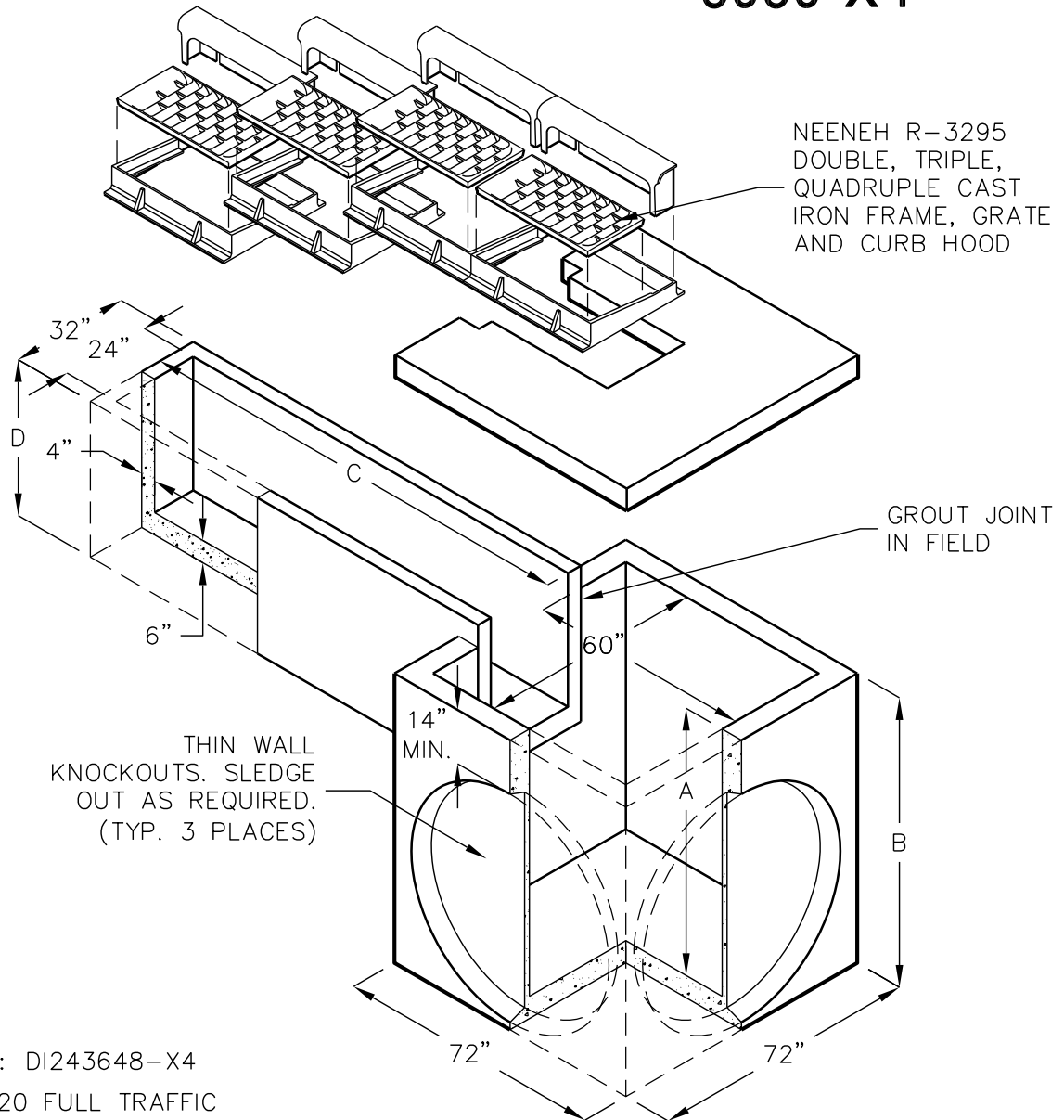

EXAMPLE SHOWN: DI243648-X4
 DESIGN LOAD: H20 FULL TRAFFIC
 CUSTOM SIZES ALSO AVAILABLE.
 DIMENSION 'C' = VARIABLE AS REQUIRED.
 DIMENSION 'D' = VARIABLE UP TO 78" MAX (72" I.D.).

Model No.		Dimensions	
DI Model	Model Suffix	A	B
DI606036-	X2 ,X3, X4	36"	42"
DI606048-		48"	54"
DI606060-		60"	66"
DI606072-		72"	78"

Model Suffix	No. of Grates	Dimensions	
		C	D
X2	2	41 1/2"	36"
X3	3	79"	48"
X4	4	116 1/2"	60"

FOR COMPLETE DESIGN
AND PRODUCT INFORMATION,
CONTACT JENSEN PRECAST.