

5000 GALLON SAND-OIL INTERCEPTOR

MODEL JZ5000EE-SO

ACCEPTED BY UPC®

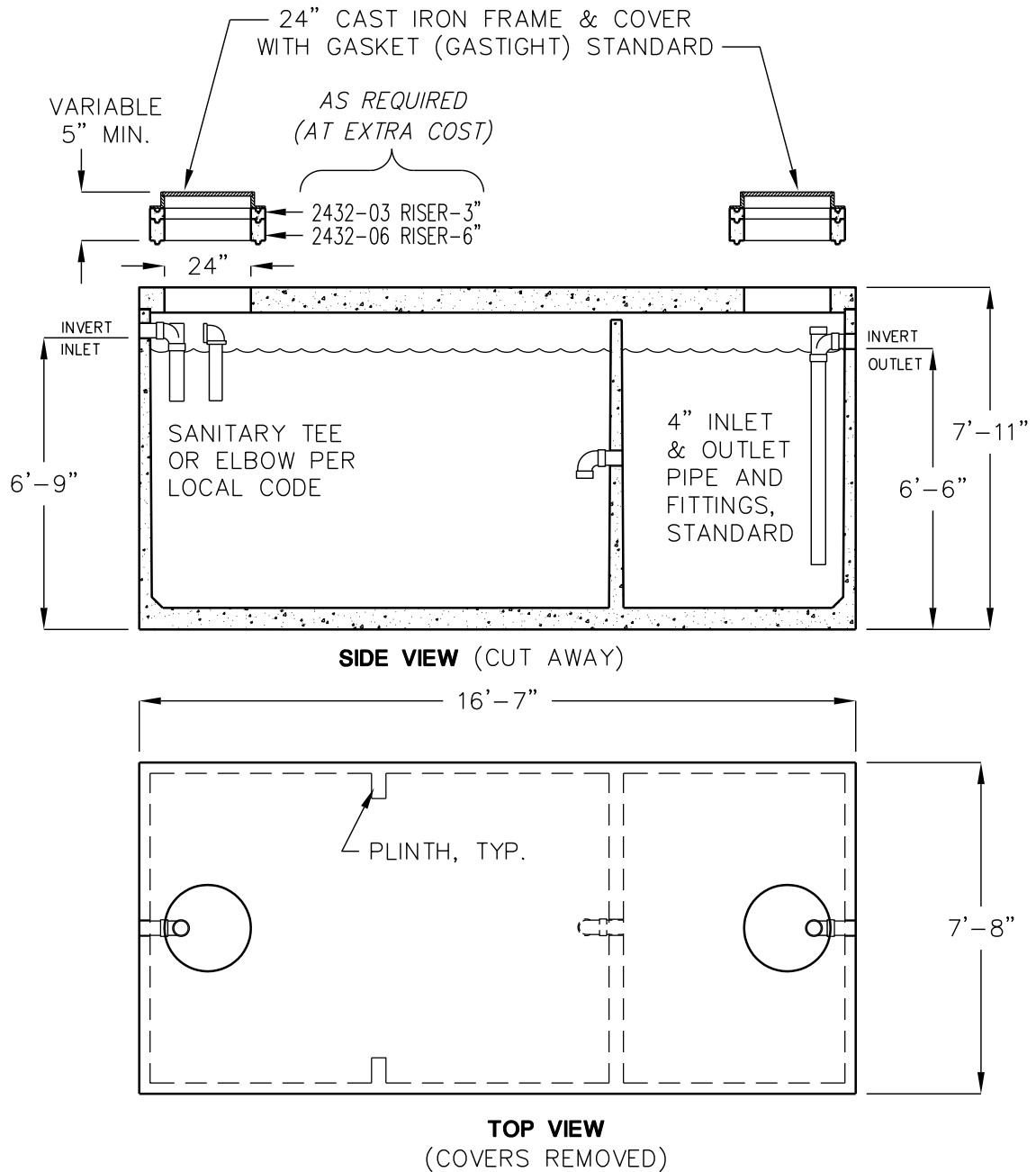

LIQUID CAPACITY: 5,000 GALLONS.

BOX DESIGN LOAD: H-20 TRAFFIC FROM 1' TO 4' OF SOIL COVER.

FOR COMPLETE DESIGN AND PRODUCT INFORMATION CONTACT JENSEN PRECAST.