

1500 GALLON GREASE INTERCEPTOR

MODEL JP1500EE-G
ACCEPTED BY UPC®

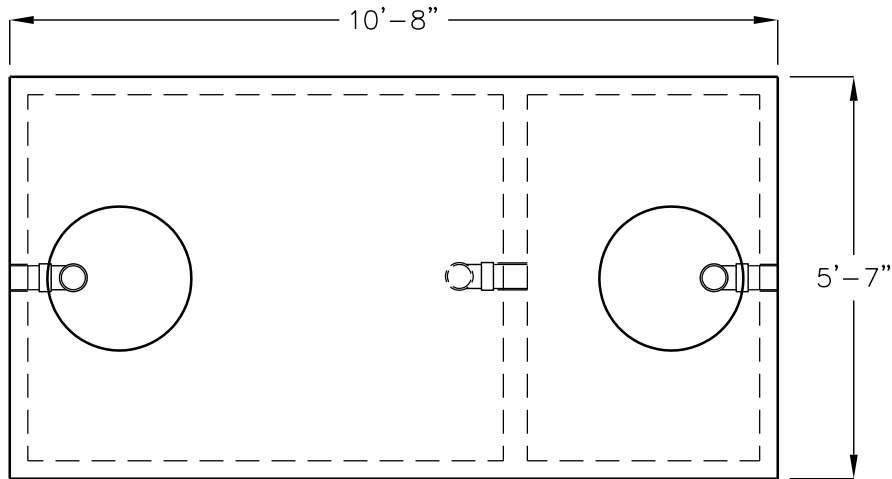
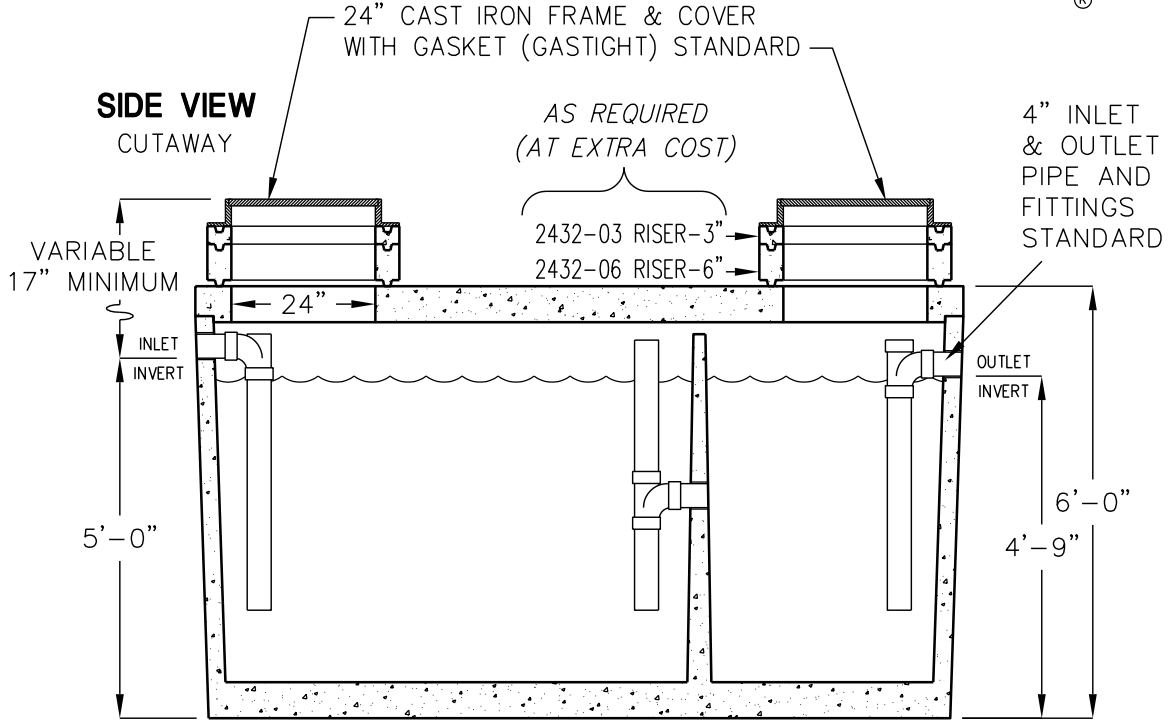

TOP VIEW
(COVERS & RISERS REMOVED)

LIQUID CAPACITY: 1,500 GALLONS.

BOX DESIGN LOAD: H-20 TRAFFIC FROM
1' TO 6' OF SOIL COVER.

FOR COMPLETE DESIGN AND PRODUCT
INFORMATION CONTACT JENSEN PRECAST.