

# JP-1200 GALLON COMMERCIAL SEPTIC TANK

TRAFFIC RATED  
ACCEPTED BY UPC®

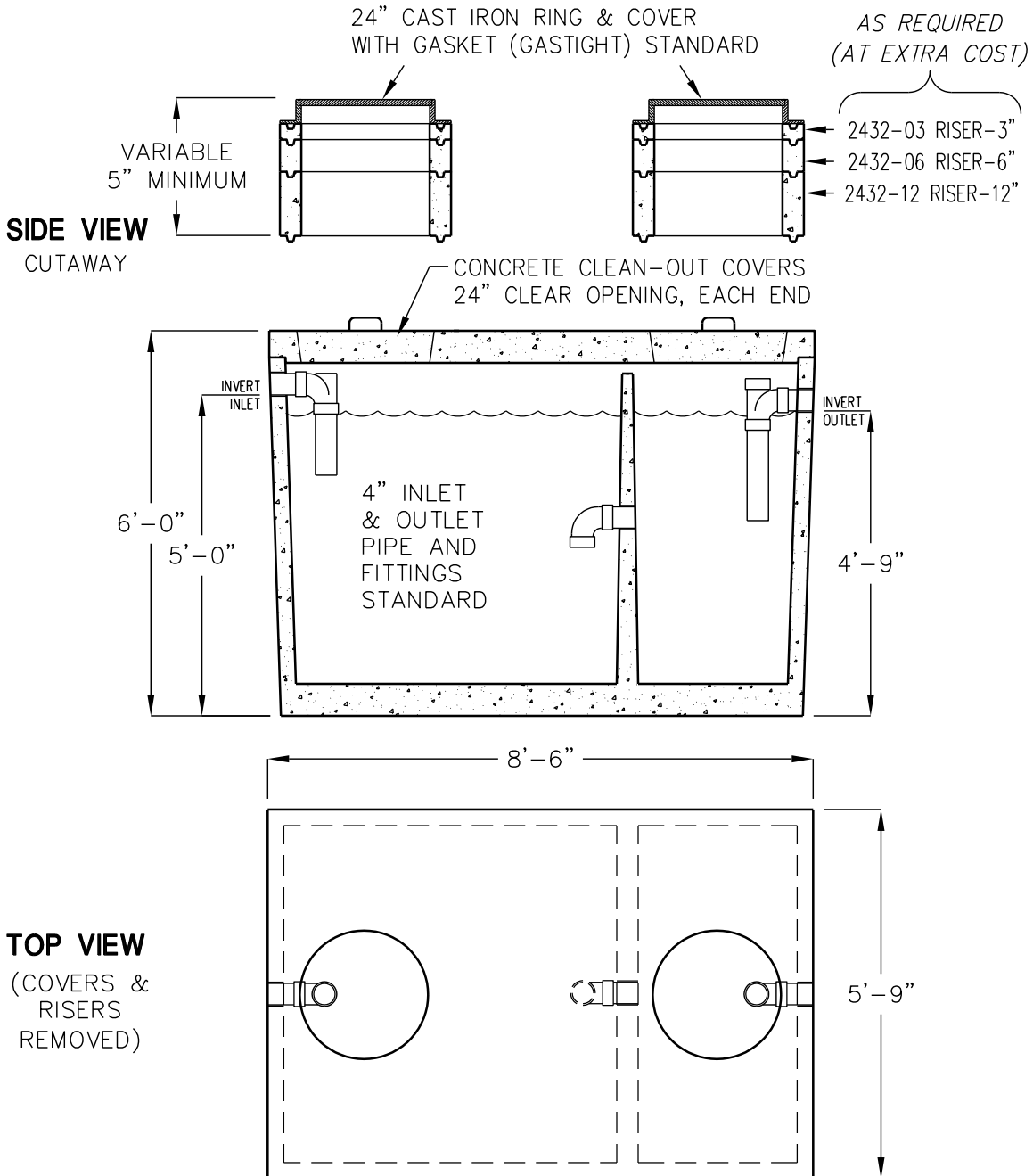

LIQUID CAPACITY: 1,200 GALLONS.

BOX DESIGN LOAD: H-20 TRAFFIC FROM 1' TO 6' OF SOIL COVER.

FOR COMPLETE DESIGN AND PRODUCT INFORMATION CONTACT JENSEN PRECAST.