

35 PG&E

3'-0"x5'-0"x3'-6" I.D.
(NOMINAL DIMENSIONS)
SPLICE BOX OR
EQUIPMENT ENCLOSURE

PG&E #02-5601*

QUICK RELEASE
ALUMINUM COVER
DESIGN LOAD:
INCIDENTAL TRAFFIC

COVER ONLY
PG&E CODE
02-5604
APPROX. WEIGHT
690 LBS.

NON-SLIP
SURFACE

OPTIONAL RISERS (EXTENSIONS)		
MODEL NO.	B	WEIGHT
35-R4	4"	270 LBS.
35-R6	6"	420 LBS.
35-R8	8"	540 LBS.
35-R12	12"	835 LBS.

04-3362

BOX ONLY
PG&E CODE
04-3361
APPROX. WEIGHT
5,380 LBS.

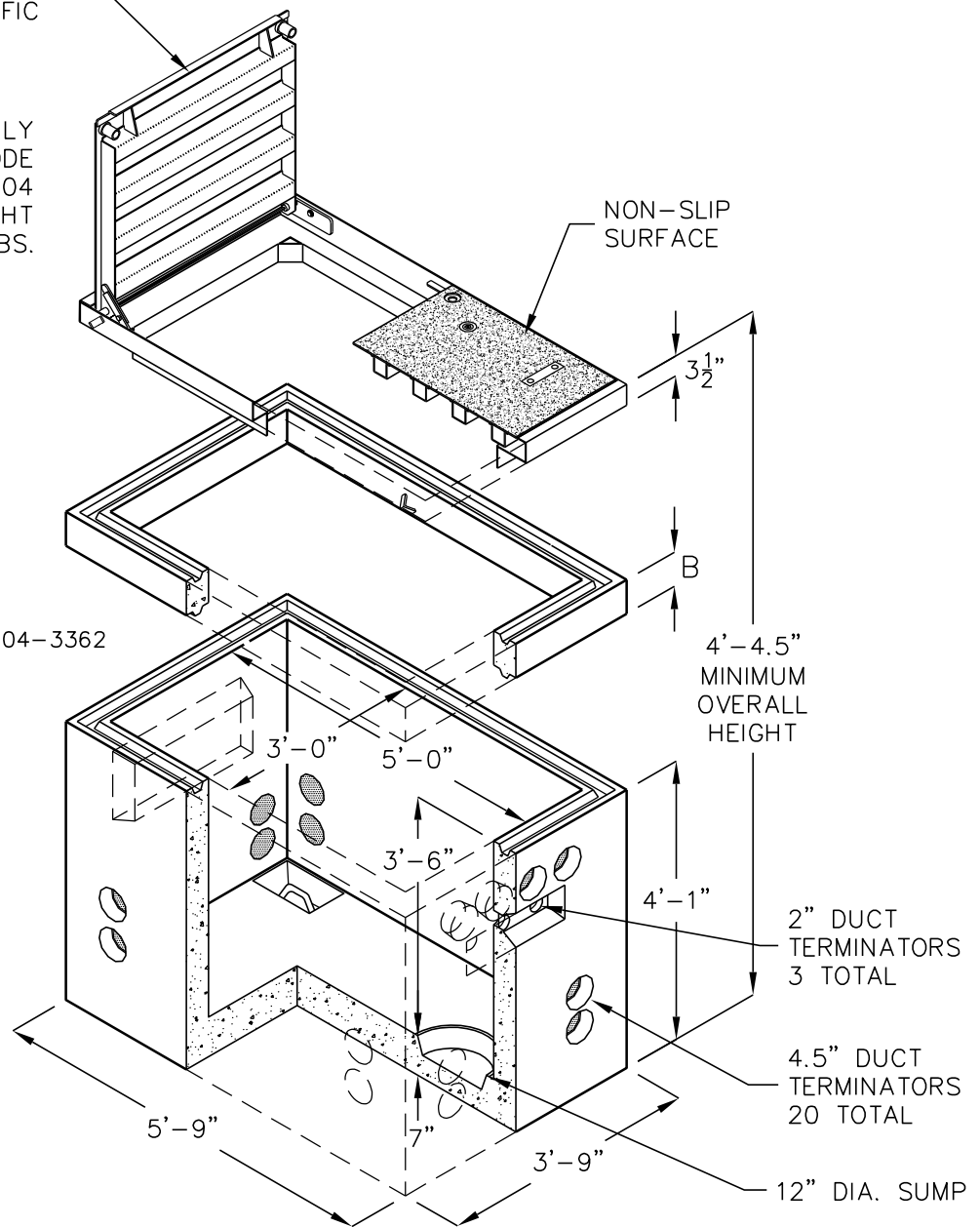

*CODE INCLUDES BOX, FRAME AND COVER ASSEMBLY.

DUCT TERMINATOR SIZE AND LOCATION, KNOCKOUTS, PULLING IRONS, ETC. PER CURRENT PG&E SPECIFICATIONS.

FOR COMPLETE DESIGN AND PRODUCT INFORMATION
CONTACT JENSEN PRECAST.

Jensen Precast reserves the right to make changes to product design and/or dimensions without notice. Please contact Jensen Precast whenever necessary for confirmation or advice on product design.

JENSEN
PRECAST