

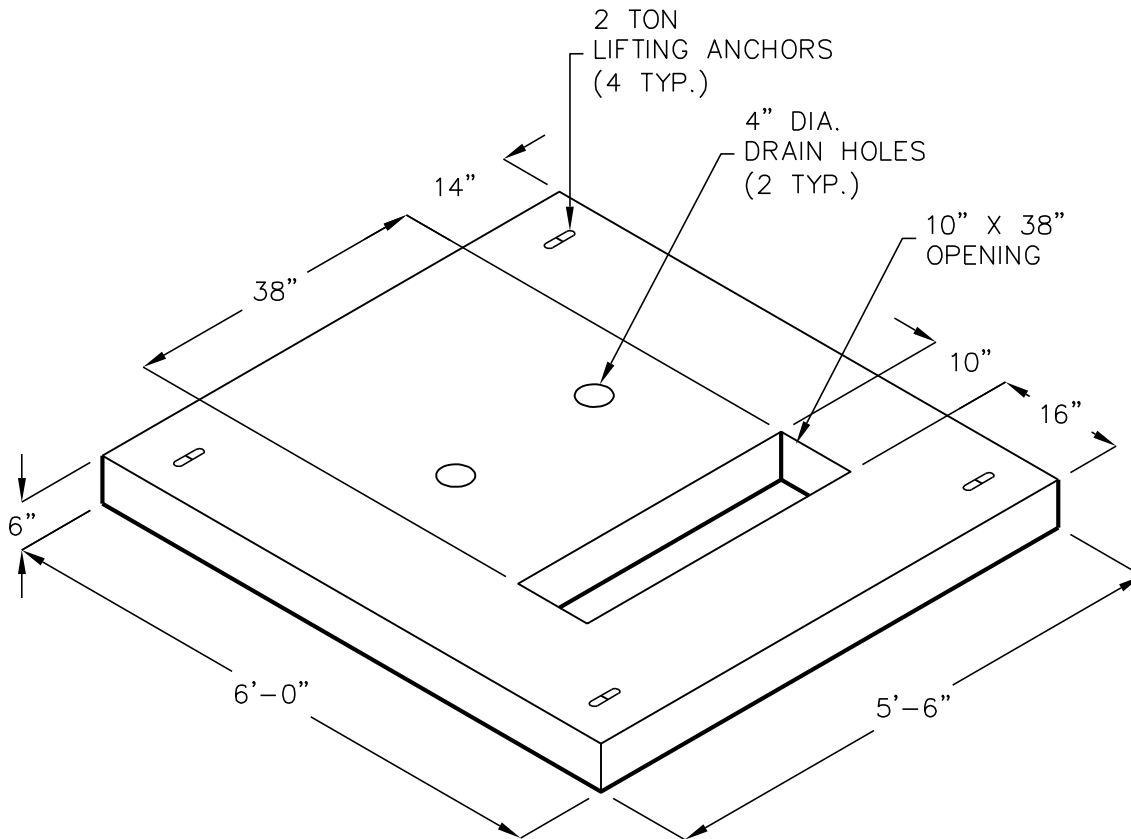

6672-1038 TRANSFORMER PAD

THREE PHASE 75-112 KVA



FOR COMPLETE DESIGN
AND PRODUCT INFORMATION
CONTACT JENSEN PRECAST.