

# 1500 GALLON SAND-OIL INTERCEPTOR

MODEL JP1500EE-SO  
ACCEPTED BY UPC®

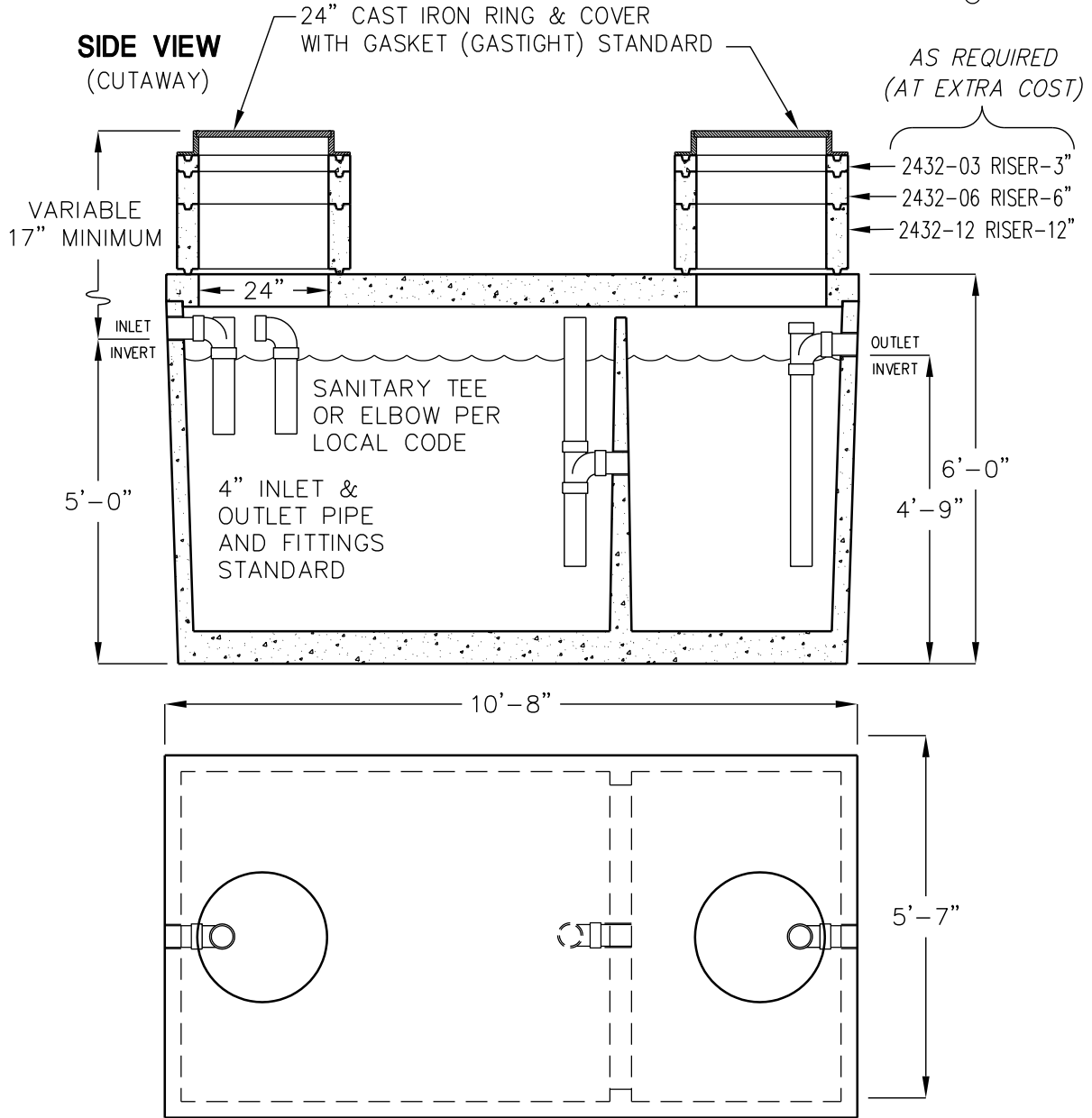

## TOP VIEW

(COVERS & RISERS REMOVED)

LIQUID CAPACITY: 1,500 GALLONS.

BOX DESIGN LOAD: H-20 TRAFFIC FROM  
1' TO 6' OF SOIL COVER.

FOR COMPLETE DESIGN AND PRODUCT  
INFORMATION CONTACT JENSEN PRECAST.