

DROP INLET

24"x36" I.D.
 (NOMINAL DIMENSIONS)
 WITH FRAME AND GRATE

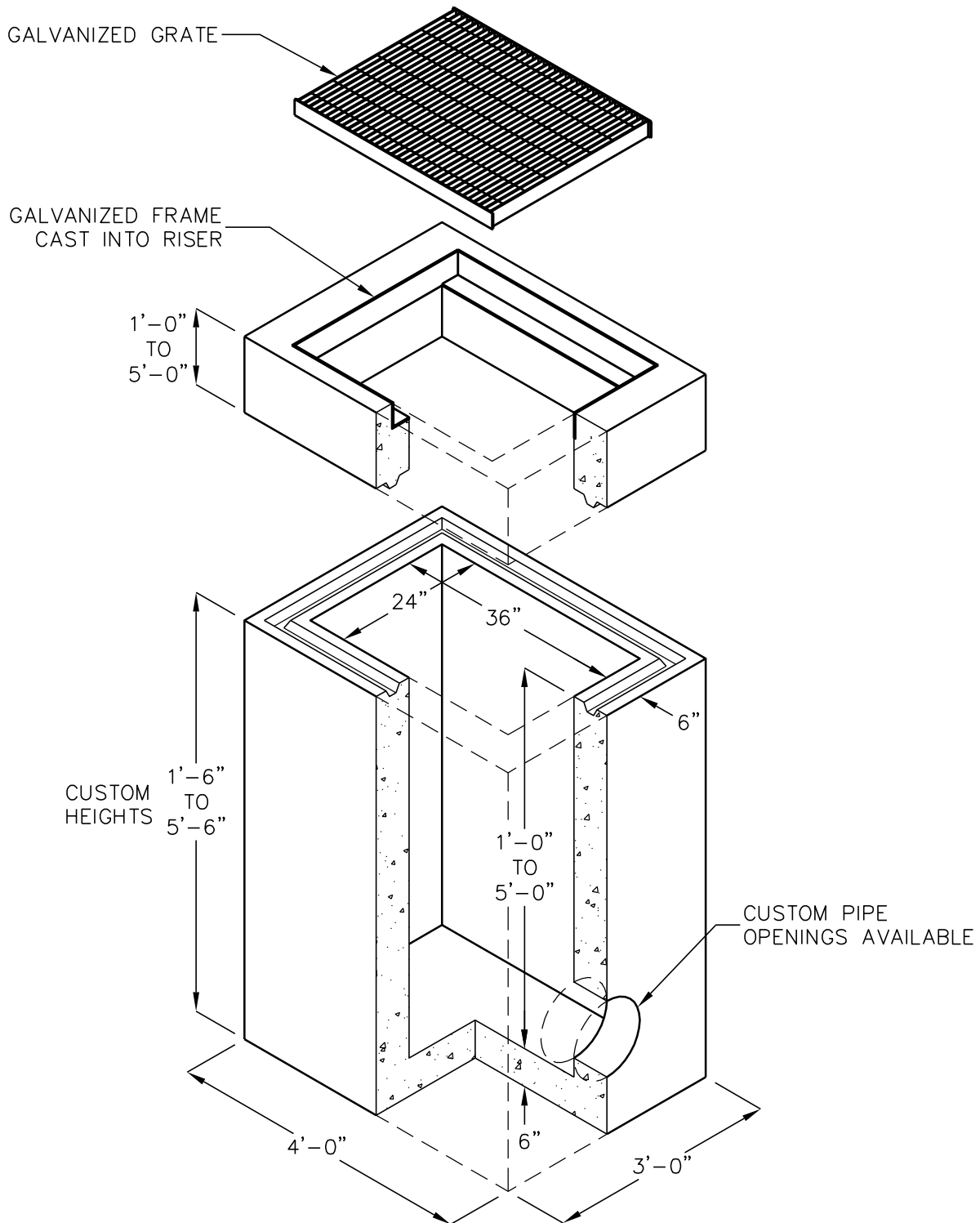

FOR COMPLETE DESIGN AND PRODUCT INFORMATION
 CONTACT JENSEN PRECAST.