

TRANSFORMER PAD MODEL RP9696

ROSEVILLE ELECTRIC
3 PHASE TRANSFORMER
750/1000 KVA

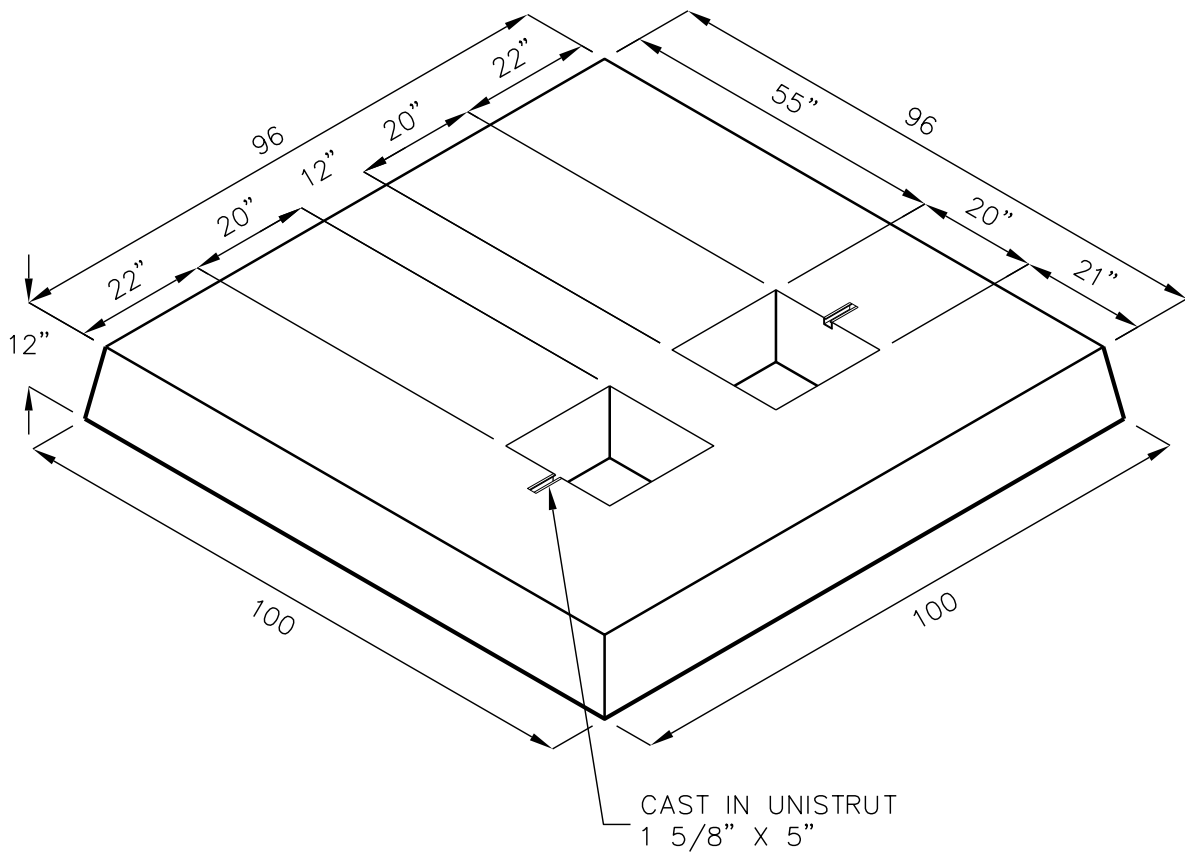

APPROX. WEIGHT:
9,230 LBS.

FOR COMPLETE DESIGN AND
PRODUCT INFORMATION,
CONTACT JENSEN PRECAST.