

2500 GALLON SAND-OIL INTERCEPTOR

MODEL JZ2500EPE-SO

LISTED BY UPC®

NORTHERN CALIFORNIA

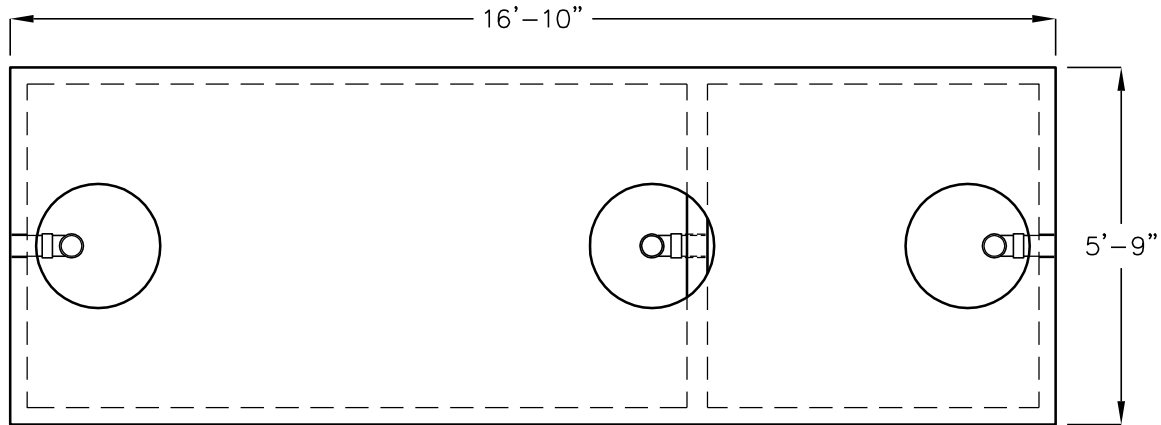

TOP VIEW
(COVERS AND RINGS REMOVED)

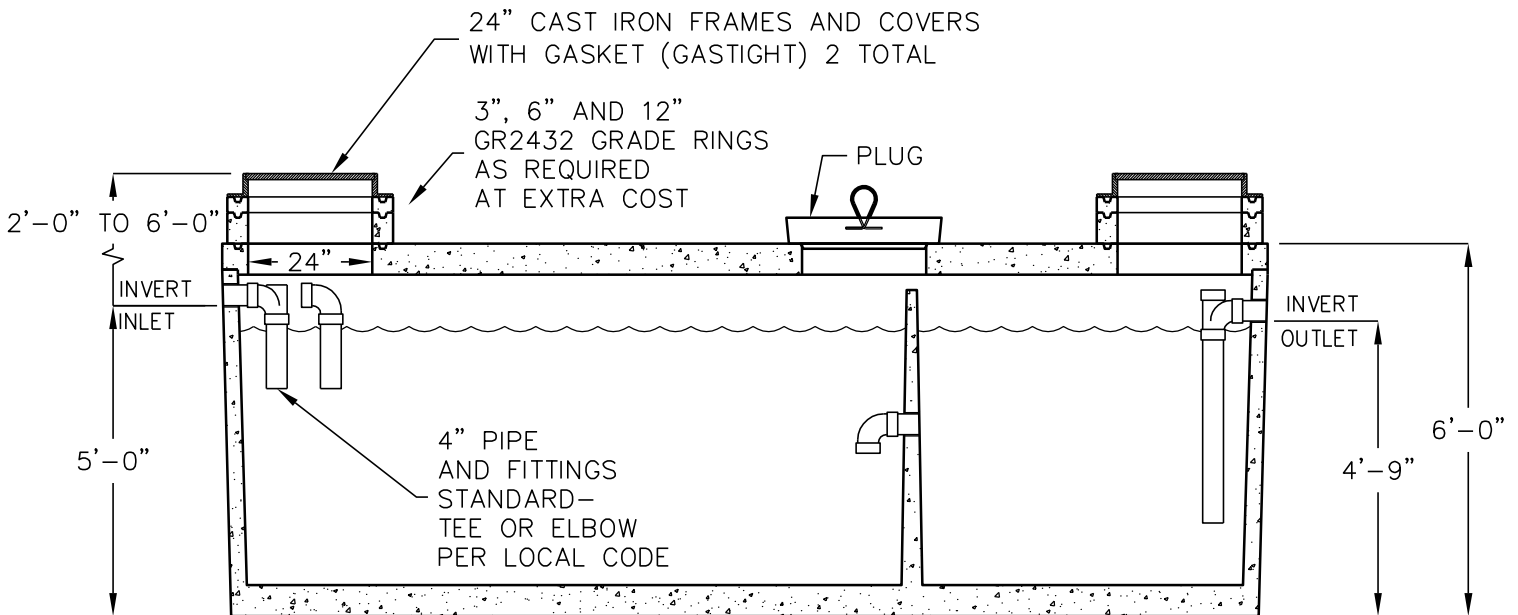

SIDE SECTION VIEW

OPERATING CAPACITY: 2,500 GALLONS.

DESIGN LOAD: H-20 TRAFFIC WITH DRY SOIL CONDITIONS
(WATER LEVEL BELOW TANK) AND 1'-5' EARTH COVER.

SUITABLE SUB-BASE BEDDED WITH GRANULAR MATERIAL
SHALL BE PREPARED TO HANDLE ANTICIPATED LOADS.

FOR COMPLETE DESIGN AND PRODUCT INFORMATION
CONTACT JENSEN PRECAST.

MINIMUM EXCAVATION
6'-9" x 17'-10"
x REQ'D DEPTH