

# 1500 GALLON SAND-OIL INTERCEPTOR

MODEL JP1500EE-SO  
ACCEPTED BY UPC®

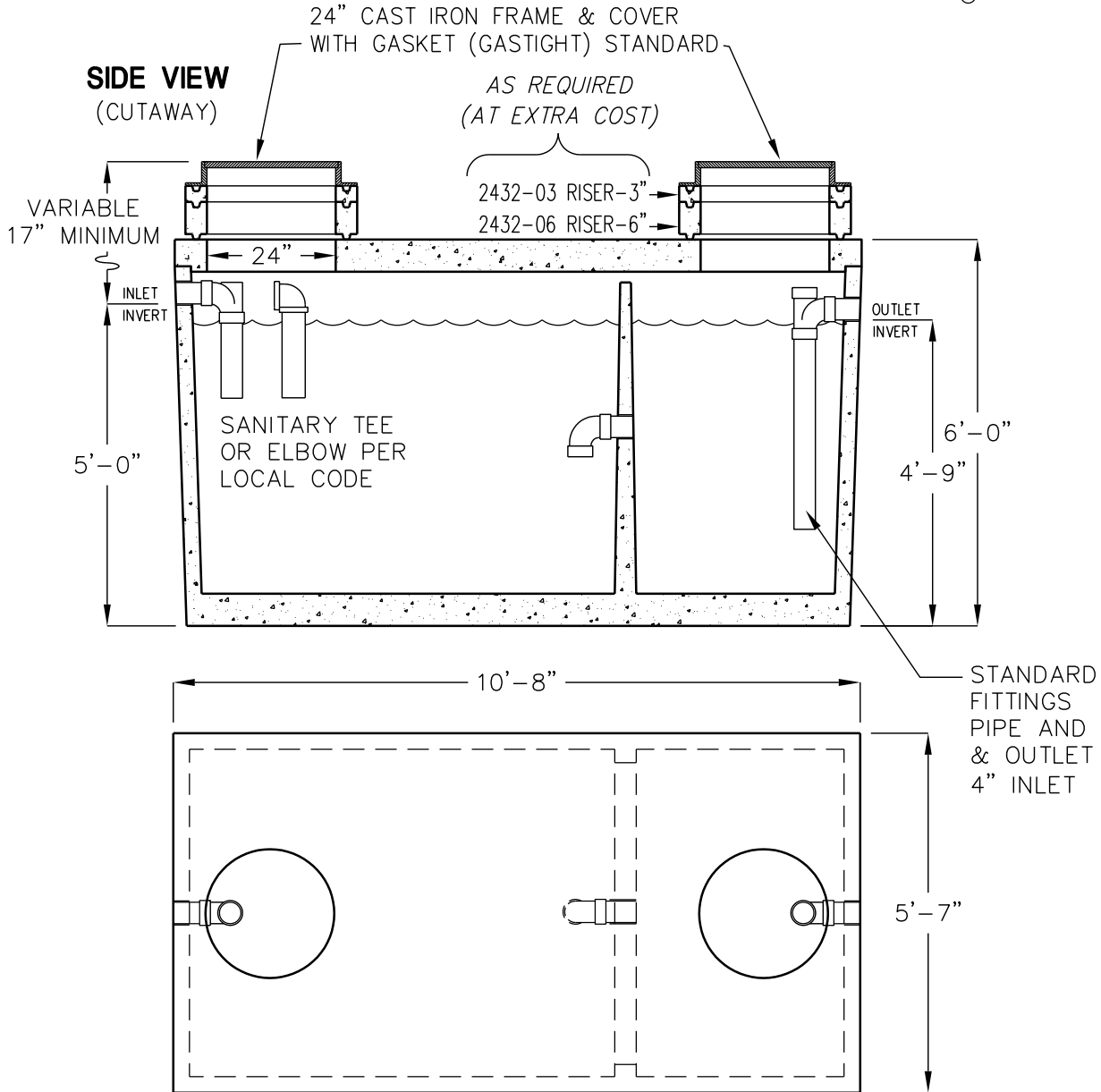

**TOP VIEW**  
(COVERS & RISERS REMOVED)

LIQUID CAPACITY: 1,500 GALLONS.

BOX DESIGN LOAD: H-20 TRAFFIC FROM 1' TO 6' OF SOIL COVER.

FOR COMPLETE DESIGN AND PRODUCT INFORMATION CONTACT JENSEN PRECAST.