

1200 GALLON SAND-OIL INTERCEPTOR

MODEL JP1200EE-SO
ACCEPTED BY UPC®

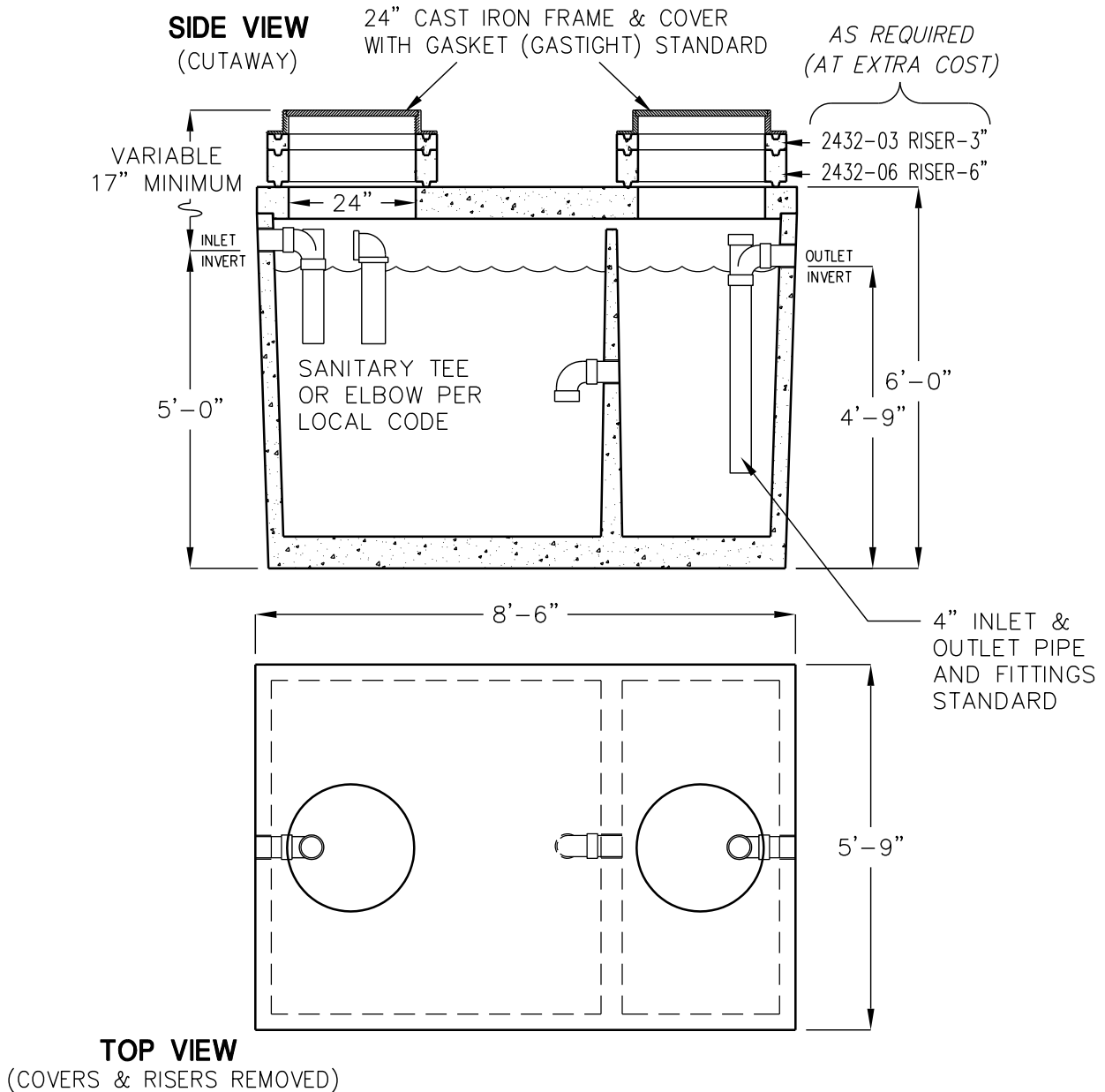

LIQUID CAPACITY: 1,200 GALLONS.

BOX DESIGN LOAD: H-20 TRAFFIC FROM 1' TO 6' OF SOIL COVER.

FOR COMPLETE DESIGN AND PRODUCT INFORMATION CONTACT JENSEN PRECAST.