

# 1000 GALLON CLARIFIER

MODEL CL1000

ACCEPTED BY UPC®

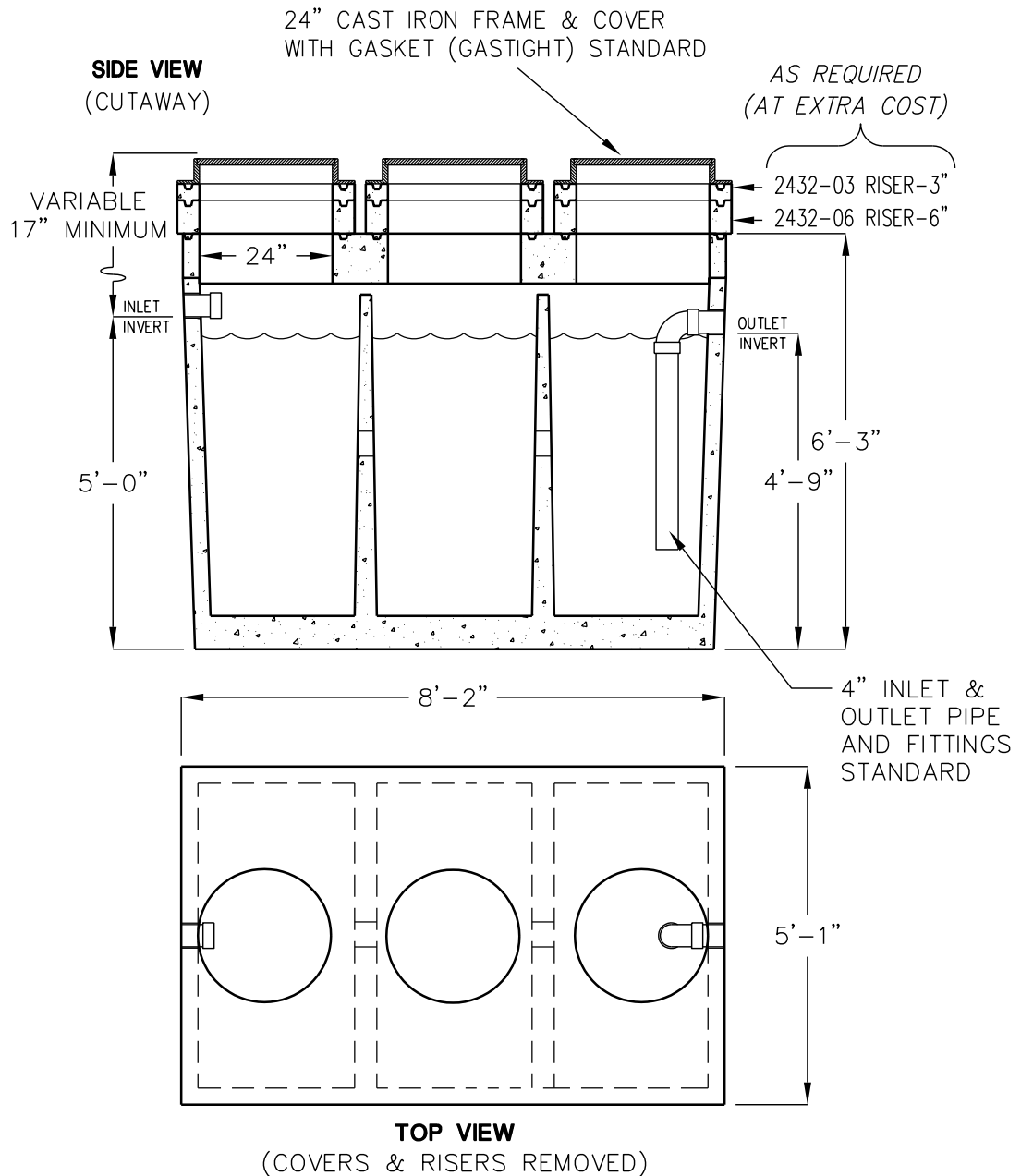

LIQUID CAPACITY: 1,000 GALLONS.

BOX DESIGN LOAD: H-20 TRAFFIC FROM  
1' TO 6' OF SOIL COVER.

FOR COMPLETE DESIGN AND PRODUCT  
INFORMATION CONTACT JENSEN PRECAST.