

4000 GALLON SAND-OIL INTERCEPTOR

MODEL JZ4000EPE-SO

LISTED BY UPC®

NORTHERN CALIFORNIA

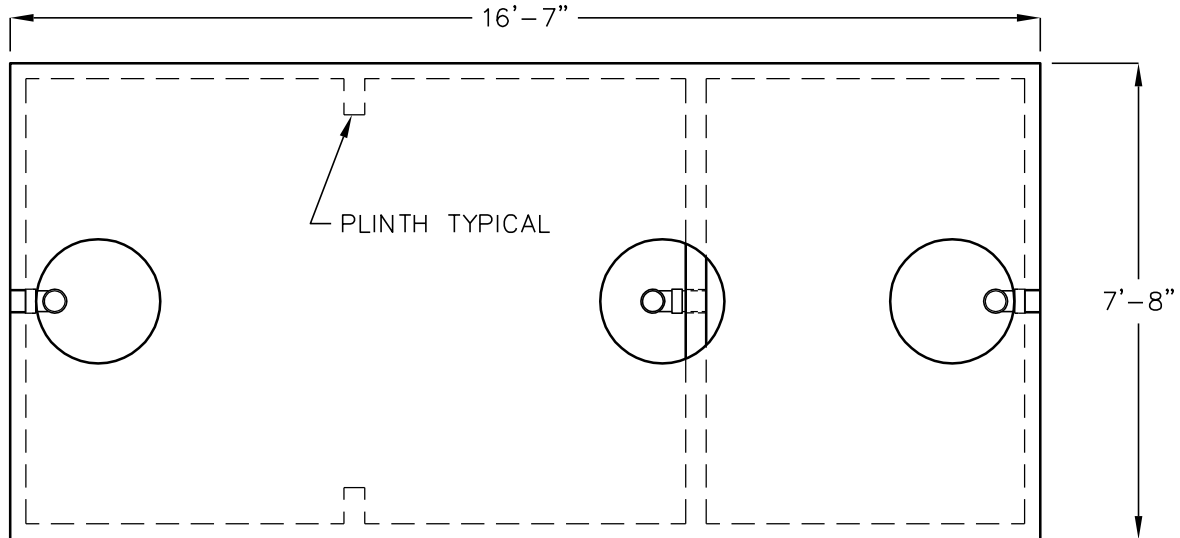

TOP VIEW
(COVERS AND RINGS REMOVED)

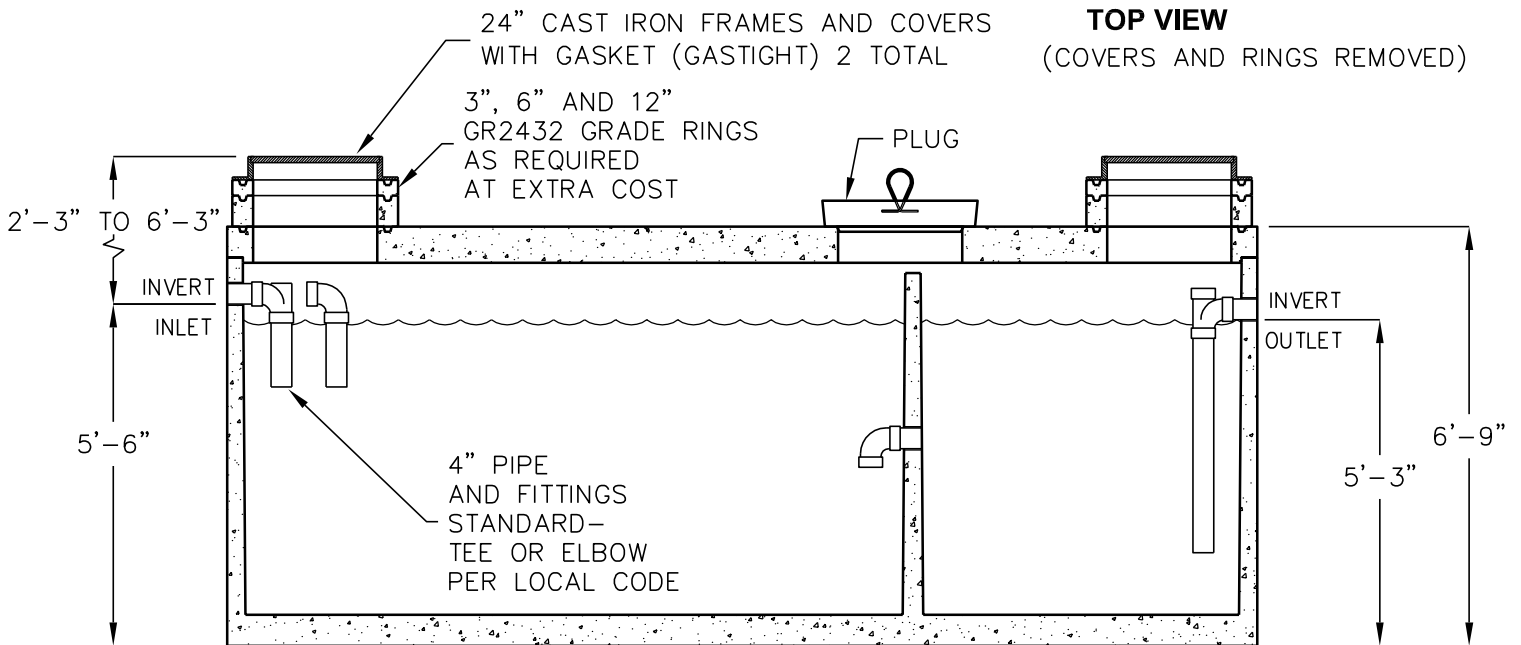

SIDE SECTION VIEW

OPERATING CAPACITY: 4,000 GALLONS.

DESIGN LOAD: H-20 TRAFFIC WITH DRY SOIL CONDITIONS
(WATER LEVEL BELOW TANK) AND 1'-5' EARTH COVER.

SUITABLE SUB-BASE BEDDED WITH GRANULAR MATERIAL
SHALL BE PREPARED TO HANDLE ANTICIPATED LOADS.

FOR COMPLETE DESIGN AND PRODUCT INFORMATION
CONTACT JENSEN PRECAST.

MINIMUM EXCAVATION
8'-8" x 17'-7"
x REQ'D DEPTH